

1. Introduction

This release of the aseXML schema defines the new namespace as “urn:aseXML:r9” and is based on the <http://www.w3.org/2001/XMLSchema> specification version 1.0. The schema is based on the aseXML schema r8 with target namespace of “urn:aseXML:r8” that was migrated from the r7 patch 1 schema.

The schema is changed as result of the MSATS 2 functional requirements and required fixes of MSATS 1.1, the Gas FRC transaction definitions and convergence requirements for the aseXML schema. This document defines the list of the files included in various releases of the aseXML schema to date as well as the changes in each file.

This schema allows for interoperability. After transitional period, the interoperability component of the schema will be removed.

The main changes are detailed below.

- It incorporates the changes from the meter register workshop, resulting in the specification of MSATS V2.
- It corrects two minor defects in MSATS V1.1 related to standing data – the use of the term EstablishmentInstructions instead of EstimationInstructions, and the definition of AverageDailyLoad on datastreams as a decimal instead of an integer.
- The definitions of DLF Values and Meter Test Result Accuracy are further restricted to limit these fields to more realistic values.
- The Transaction Type Code has been added in the relevant rows for C1 reports clarification
- Two transactions: CATSNotification and MeterDataNotification were altered as result of their use in Gas and B2B. Alteration does not affect the MSATS transactions as the added elements will not be used.

Due to the extensive nature of changes to the schema for B2B and Gas FRC transactions, the summary of changes is not provided for this release.

- A new section 4 was added to define the changes resulting from the parser validation tests.
- The associated zip file provides, in addition to the r9 schema, a set of sample XML files that uses the relative path for schemaLocation.

2. Schema Manifest

The table below summarises the various schema releases and files included within those releases. The release identifier in the file name reflects when the file was last modified. All files included in a release are marked with a black tick. A cross means the file was removed from the release. The following legend is applied to the table:

- Files modified between r7 and r7 patch1 are marked with purple tick.
- Files modified between r7 patch1 and r8 are marked with red tick.
- Files modified between r8 and r9 are marked with blue tick.
- Files modified between r7 patch1 and r9 are marked with teal tick.

File names	r7	r7 patch 1	r8	r9
Acknowledgements_r6.xsd	✓	✓		✓
Acknowledgements_r7.xsd			✓	
Appointments_r8.xsd			✓	
Appointments_r9.xsd				✓

AseXML_r7.xsd	✓	✓		
AseXML_r8.xsd			✓	
AseXML_r9.xsd				✓
CATSReports_r6.xsd	✓	✓	✓	
CATSReports_r9.xsd				✓
CATSTableReplication_r6.xsd	✓	✓	✓	
CATSTableReplication_r9.xsd				✓
ClientInformation_r7.xsd	✓	✓	✓	
ClientInformation_r9.xsd				✓
Common_r7.xsd	✓	✓		
Common_r8.xsd			✓	
Common_r9.xsd				✓
CustomerDetails_r8.xsd			✓	
CustomerDetails_r9.xsd				✓
CustomerTransfer_r7.xsd	✓	✓	✓	
CustomerTransfer_r9.xsd				✓
Electricity_r7.xsd	✓	✓	✓	
Electricity_r9.xsd				✓
Events_r6.xsd	✓	✓	✓	
Events_r9.xsd				✓
Faults_r8.xsd			✓	✓
Gas_r6.xsd	✓	✓	✓	
Gas_r9.xsd				✓
Header_r6.xsd	✓	✓		
Header_r7.xsd			✓	
Header_r9.xsd				✓
MDMTRReport_r7.xsd	✓	✓	✓	✓
MeterConfig_r8.xsd			✓	x
MeterDataManagement_r6.xsd	✓	✓	✓	
MeterDataManagement_r9.xsd				✓
NetworkBilling_r8.xsd			✓	
NetworkBilling_r9.xsd				✓
NMIDataAccess_r6.xsd	✓	✓	✓	
NMIDataAccess_r9.xsd				✓
Reports_r6.xsd	✓	✓	✓	
Reports_r9.xsd				✓
ServiceOrder_r8.xsd			✓	
ServiceOrder_r9.xsd				✓
TableReplication_r7.xsd	✓	✓	✓	✓
Transactions_r6.xsd	✓	✓		
Transactions_r8.xsd			✓	
Transactions_r9.xsd				✓
Number of files included	17	17	23	22

3. File Change Summary

The section identifies and lists any changes between the various versions of the schema files and highlights any issues. Note that, in this section, the release identifier has been dropped from the file names.

3.1. Acknowledgments

- The definition of ReceiptIdentifier based on UniqueIdentifier was reinstated by means of using the r6 version of the file.

3.2. Appointments

- The definitions for the complexTypes AppointmentDateTime and AppointmentDetail were moved from ServiceOrder file to the Appointments file and modified for the purpose of readability as follows:

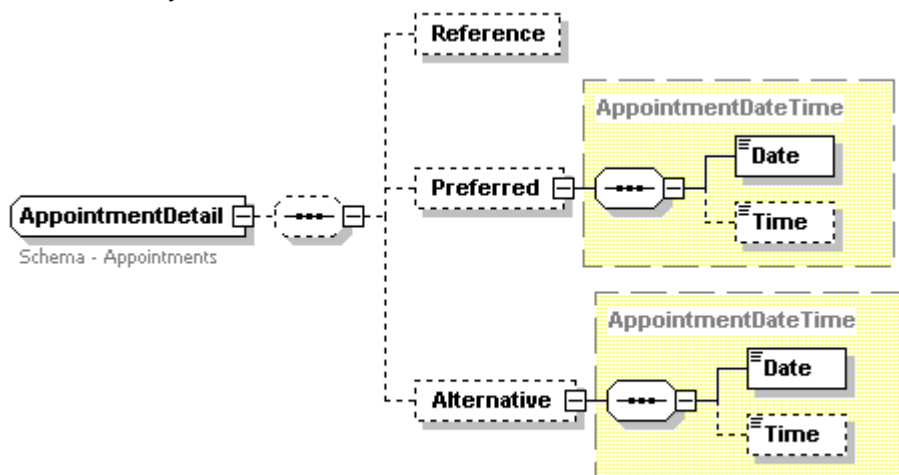

Generated with XMLSpy Schema Editor www.xmlspy.com

3.3. aseXML

- Changed aseXML namespace
- Changed names of included files affected by r9

3.4. CATSReport

- Report parameters extended with SnapshotReportParameters to request the Snapshot Report

3.5. CATSTableReplication

- Modified data stream row formats to allow for average daily load being changed from a decimal to an integer.
- Added new row formats for meter register configuration (master data and change requests)
- Added optional version attribute to modified table formats; The attribute will become mandatory after the transitional period.
- Address in the ElectricityNMIMasterGroup uses AustralianPartialAddress complex type
- Role in the CATSObjectionRow become optional
- DistributionLossFactorCodeRow extended with the version attribute due to change in the DistributionLossFactorValue type
- Party in ElectricityNMIRoleGroup declared nillable.
- Optional element TransactionTypeCode added to CATSChangeResponseRow, CATSObjectionRow and CATSObjectionResponseRow
- Added optional version attributes to the changed rows; They will become mandatory after the transitional period.
- Spelling error corrected and CATSChangeInitiationRuleRow changed in CATSChangeInitiationRuleRow

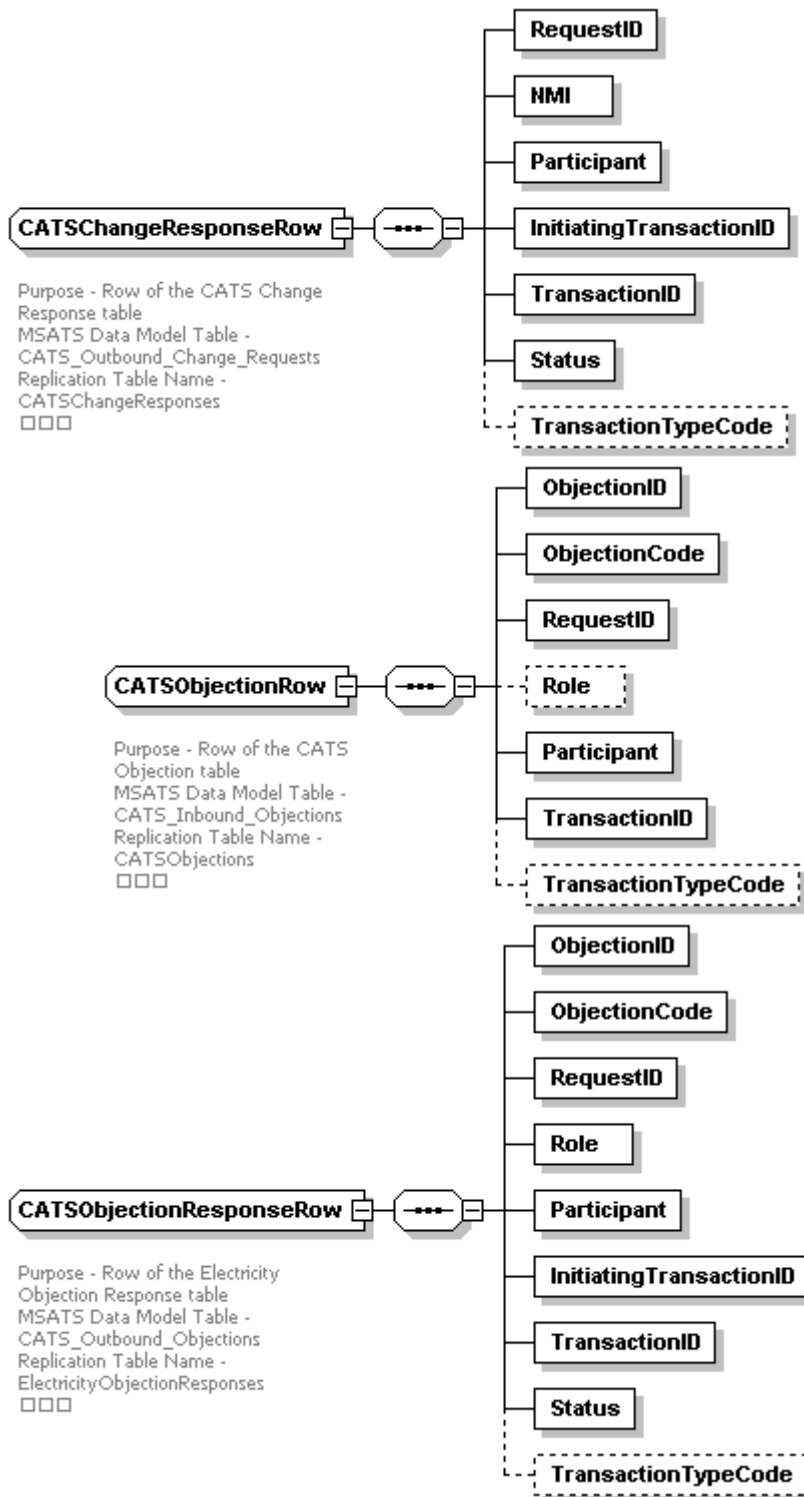

3.6. ClientInformation

- Address fields are declared nillable.
- Patterns of the address fields: FlatNumber, FloorNumber, LotNumber, LocationDescriptor extended to allow for punctuations and spaces.

3.7. Common

3.7.1. r8

- This version introduces definition for simpleType UnitsOfMeasure.

3.7.2. r9

- o Addition of meter register/register configuration types
- o MeterTestResultsAccuracy limited to (8,5) decimal, 0<= value<=100, previously just decimal
- o Introduces definition of “CSVRequestFormat” and CSVResponseFormat.

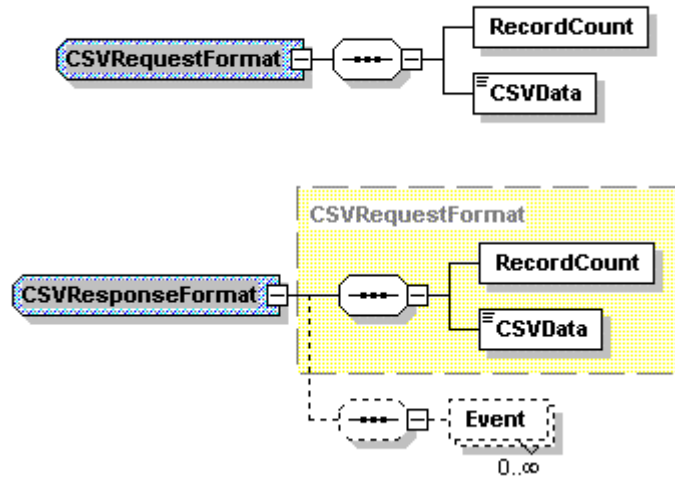

- o Added new abstract type NMITransactionBase. Same as NMISTandingData type and used as base for fuel specific concrete types in transactions that don't effectively use NMI Standing Data but need a base type that contains NMI.
- o Added complex types “CurrentRetailerConfirmationRequest”

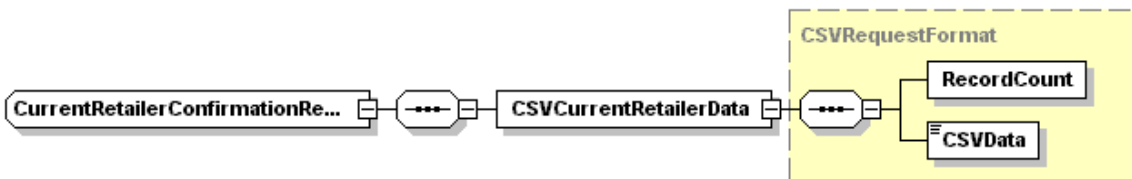

and “CurrentRetailerConfirmationResponse”

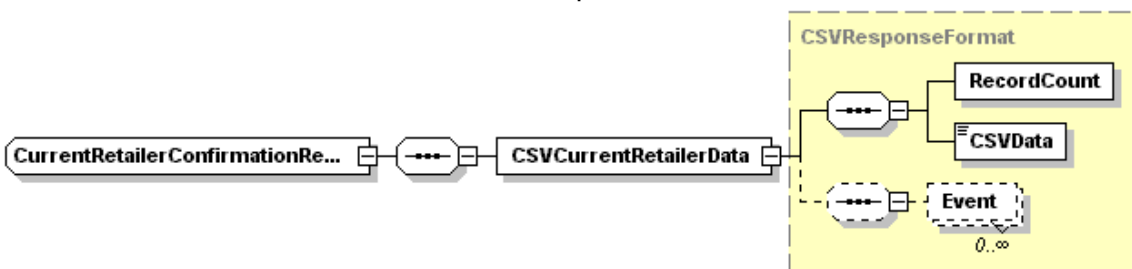

for use in transactions of same name.

3.8. CustomerDetails

- introduced the definition of complexType AmendMeterRouteDetails.

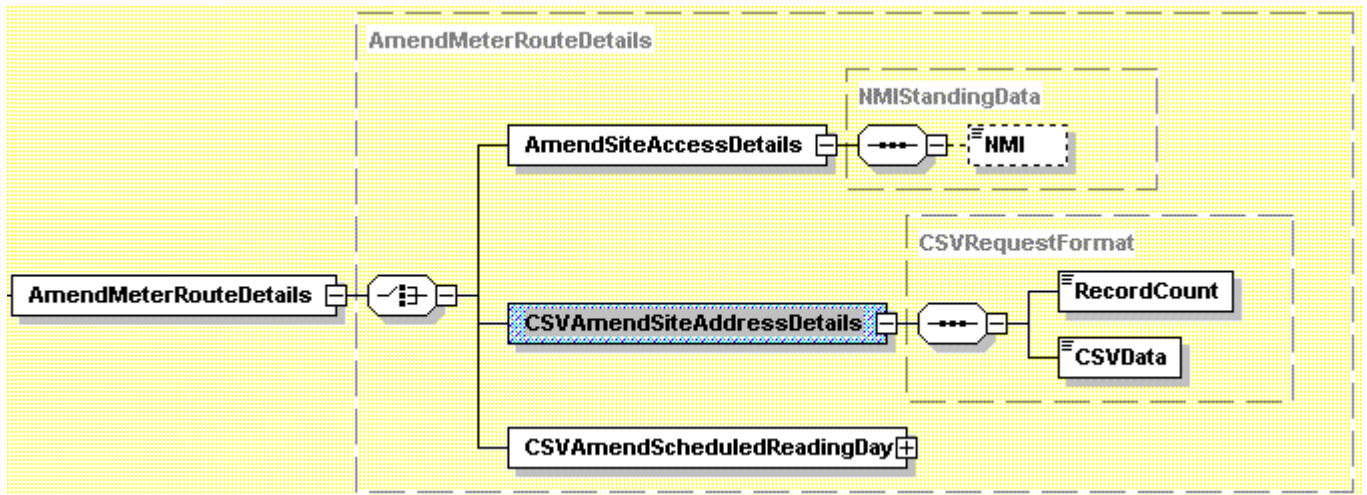

- The definition of the ServicePoint was modified by removing the element "SORDSpecialComments" and SpecialReadResonCode; and adding optional elements MelwayGridReference, DogCode, and MeterPosition.

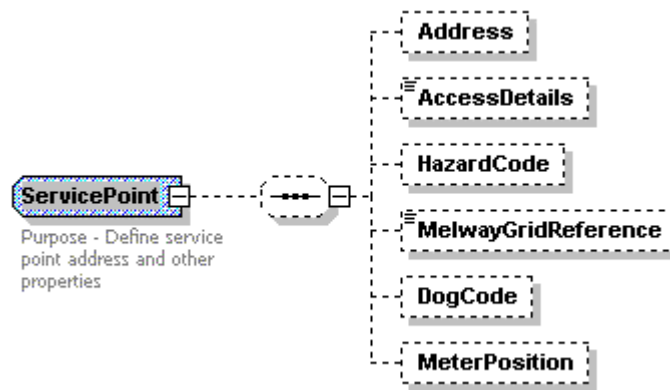

3.9. Customer Transfer

- The r9 release modifies the "Participant" element of the type CATSChangeRequestNotificationData to be nillable.

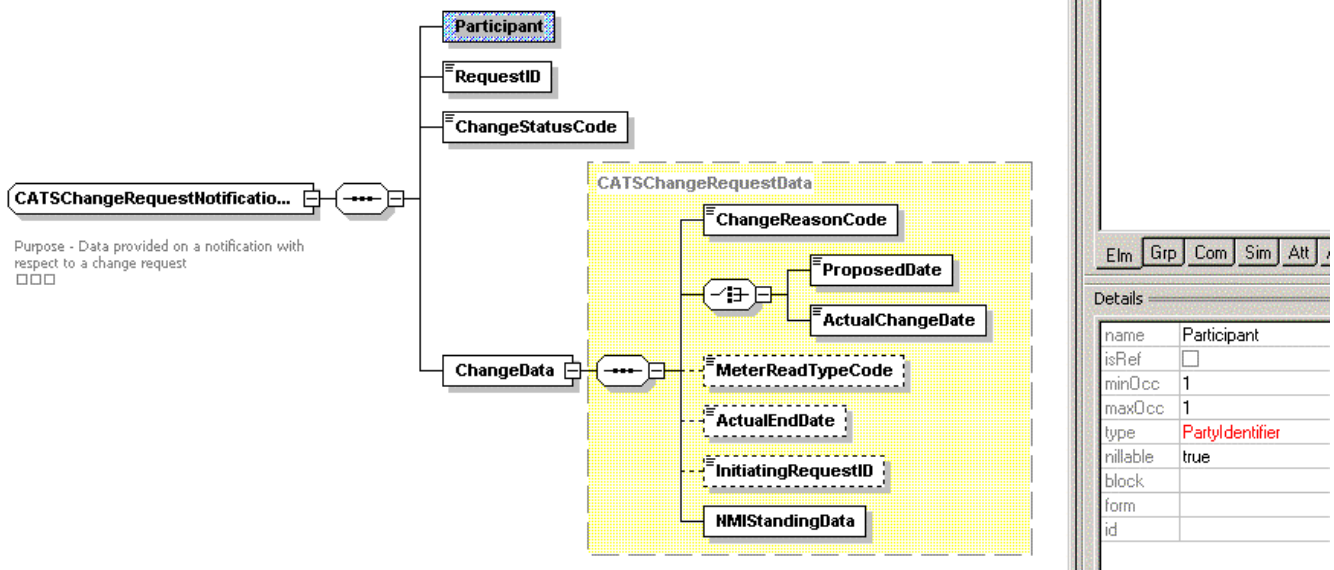

This is required because the VENCORP does not include the details of New-FRO in CATSNotification.

- An optional element ObjectionDate has been added to the CATSObjectionNotificationData.
- The version attribute of the CATSNotification has been updated to r9.
- A new complexType CATSChangeAlert has been introduced for the corresponding transaction.

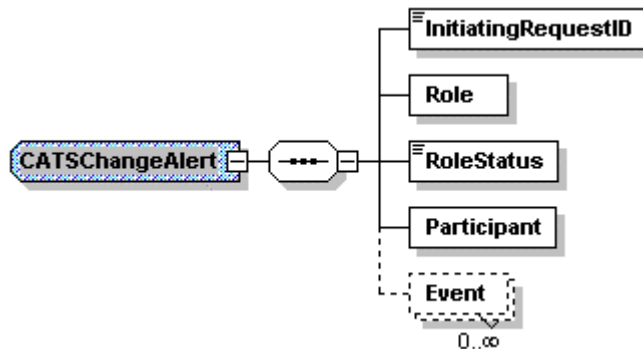

- Optional element ObjectionDate added to the CATSObjectionNotificationData. Consequently, version attribute for the CATSNotification transaction became r9. The content of MSATS CATSNotifications may remain the same because the added element is optional.

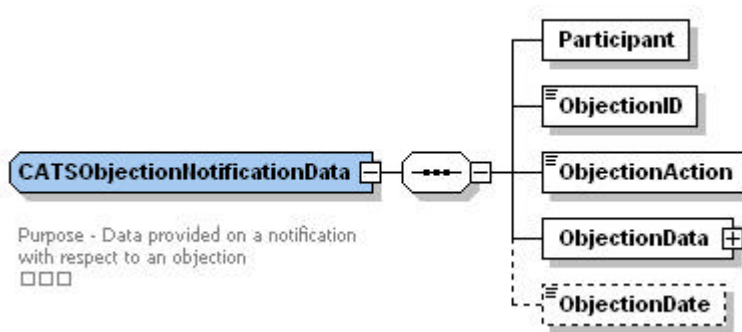

3.10. Electricity

- DLFValue limited to (6,5) decimal, 0 <= value <=2, previously just decimal
- AverageDailyLoad now integer, previously decimal
- Addition of types for MeterRegisterConfiguration
- Modifications to Meter Register
 - Adding of EstimationInstructions, AdditionalSiteInformation, AssetManagementPlan, CalibrationTables, UserAccessRights, Password, TestCalibrationProgram
 - SiteName and EstablishmentInstructions will be removed after transitional period as they are replaced by AdditionalSiteInformation and EstimationInstructions
 - NetworkTariffCode will also be removed after transitional period from the Meter record as it is already provided in the Register record.
- Added optional version attribute to Electricity standing data; Version attribute will become mandatory after transitional period.

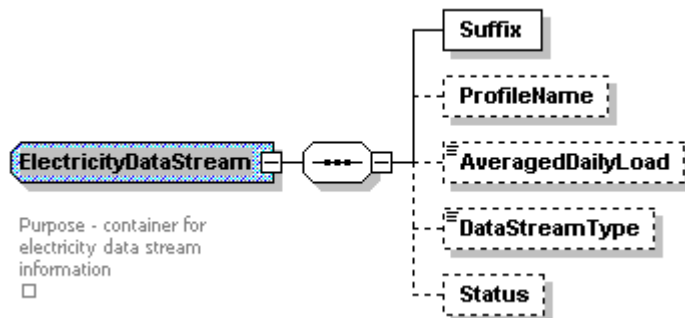

- The complexType ElectricityMeterRegisterConfiguration was defined for use in the ElectricityStandingData and the MeterConfiguration transaction:

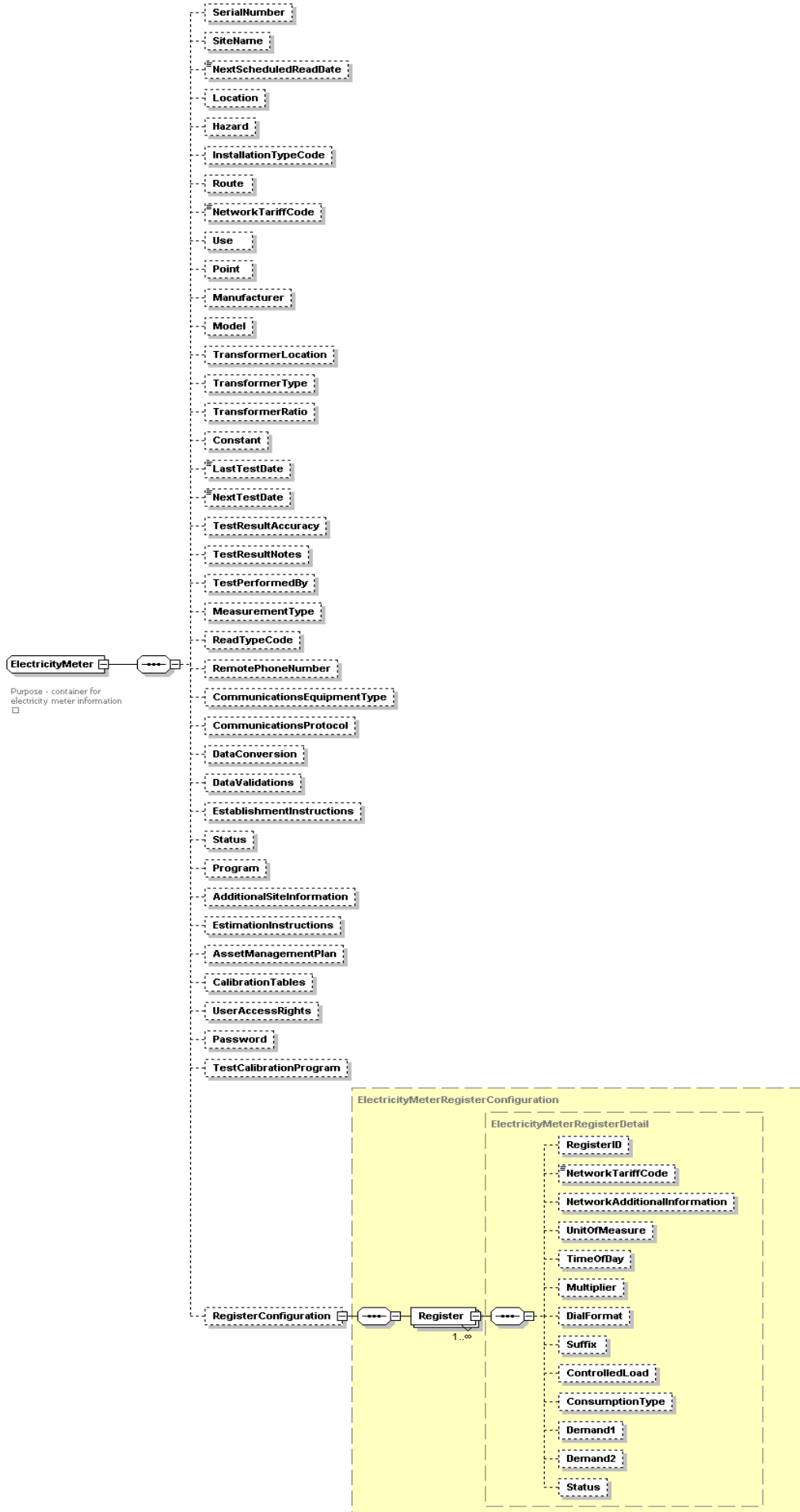

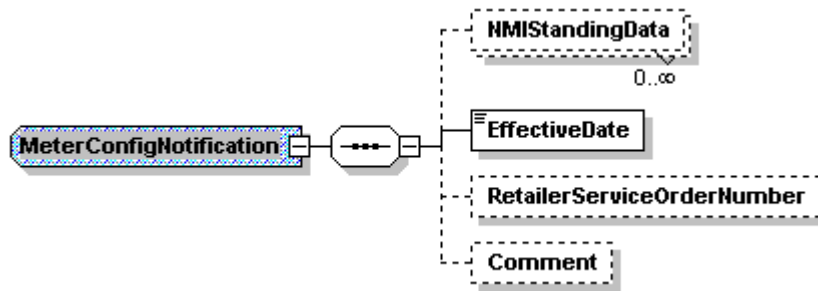

3.11. Events

- Release Identifiers placed in Events;
- Added type for release r9

3.12. Faults

- No Change

3.13. Gas

Changed the following enumerated lists to conform to the approved change items in the PBPs & the corresponding Change Logs since April 08, 2002:

- JobEnquiryCode - Fixed and remove MFA from the list.
- ReasonForNoAccess – added required values and sorted in alphabetical order. Removed “Delayed Read” from the list
- ExcludedServicesCategory – defined the new list
- GasMeterPosition – added missing elements from the read. The excel spreadsheet row height limitations doesn’t allow to print all the elements in the list.

Modified the complex type GasIntervalMeterCharge and the GasIntervalMeterStandingData to use the updated GasIntervalMeterCharge as shown below:

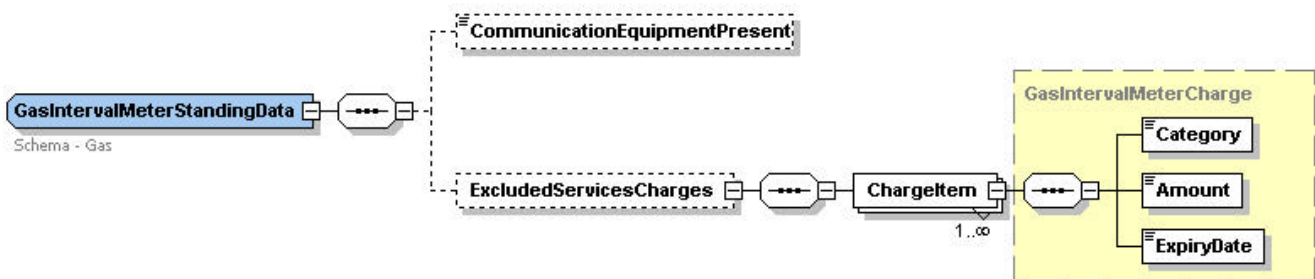

- Added the following complex types for Service Orders:
 - “GasServiceDetails”, “LoadDetails”, “GasMeterFix”, “GasMeterFixCertification” and “GasNewConnection” for use as “ServiceDetails” element in GasServiceOrderDetails type (defined in ServiceOrder file)

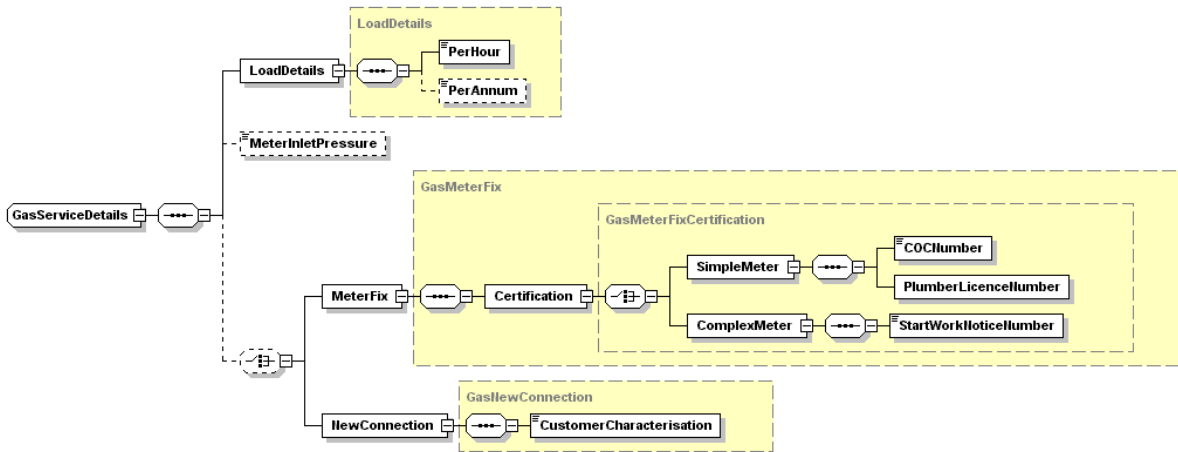

- “ServiceOrderGasCompletionData” and “ServiceOrderGasMeterData” for use as “ServiceOrderCompletion” element

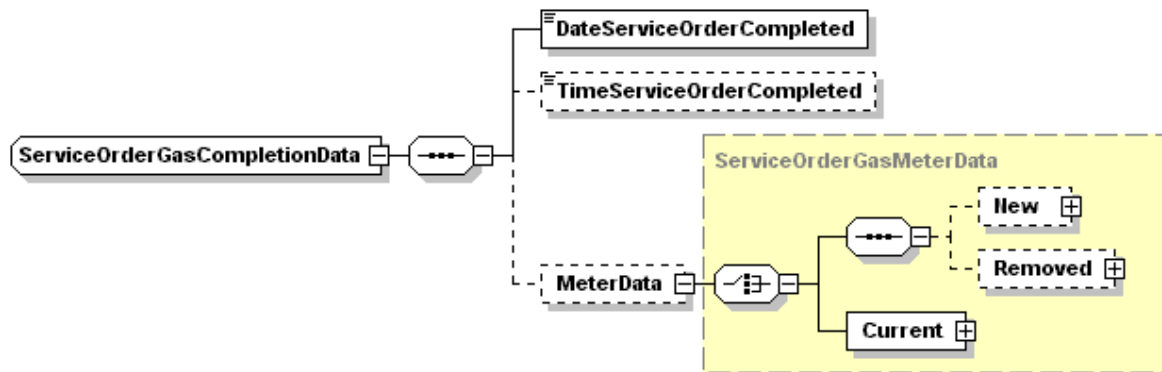

- “ServiceOrderGasNoAccessData” and “GasSpecialReadNoAccess” for use as “NoAccess” element

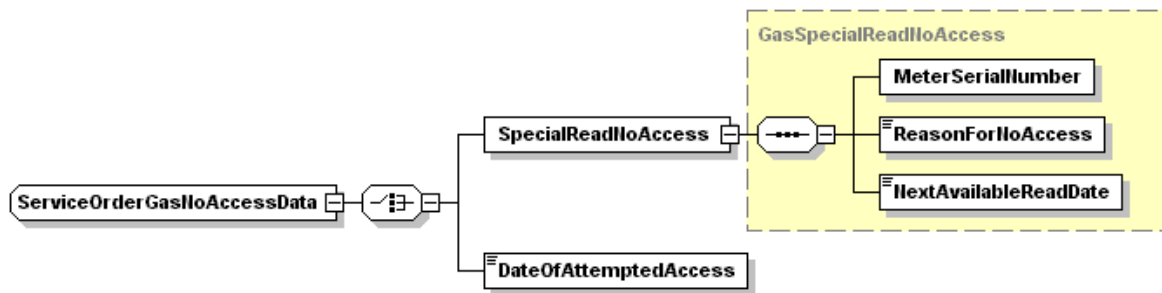

- “ServiceOrderGasJobCompletionCodes” for use as “JobCompletionCodes” element

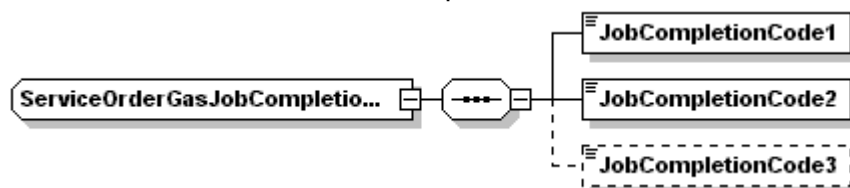

all used in GasServiceOrderNotificationData type (defined in ServiceOrder file)

- Added the actual definitions for Gas Standing Data
- “GasStandingData” concrete derivation of “NMISStandingData” abstract type

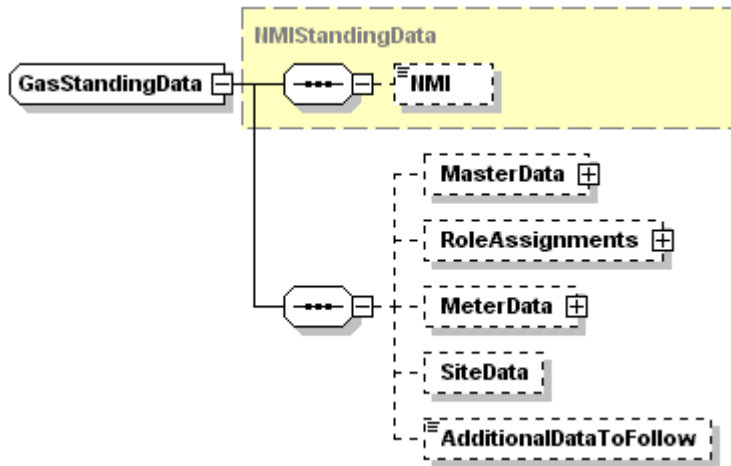

- “GasMasterStandingData” used as “MasterData” element

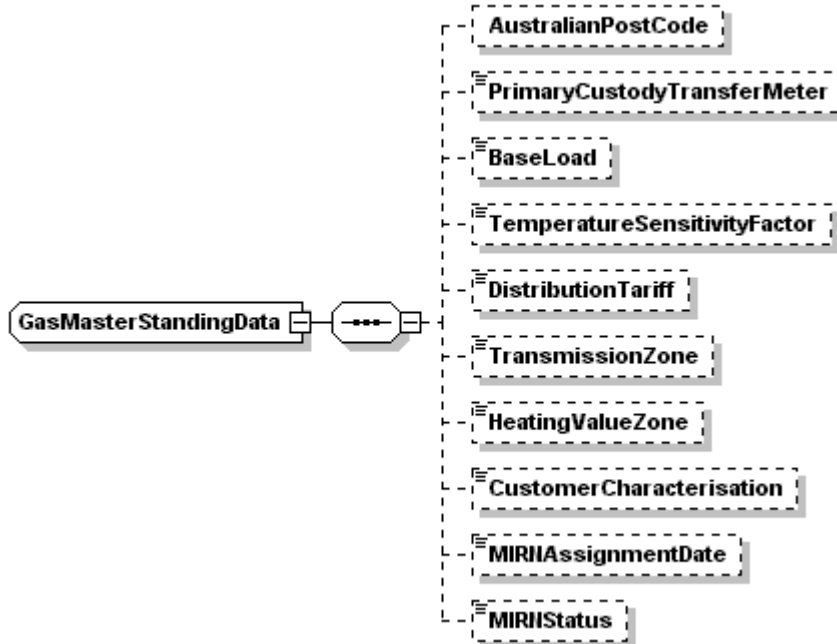

- “RoleAssignments” used as “RoleAssignments” element

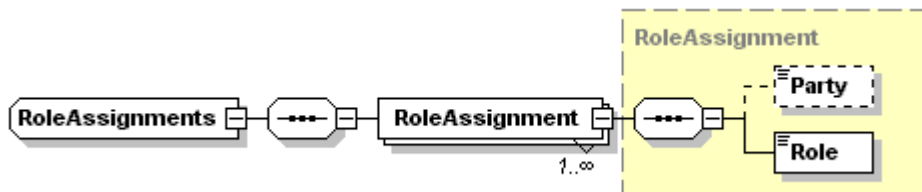

- “GasMeterStandingData” used as “MeterData” element

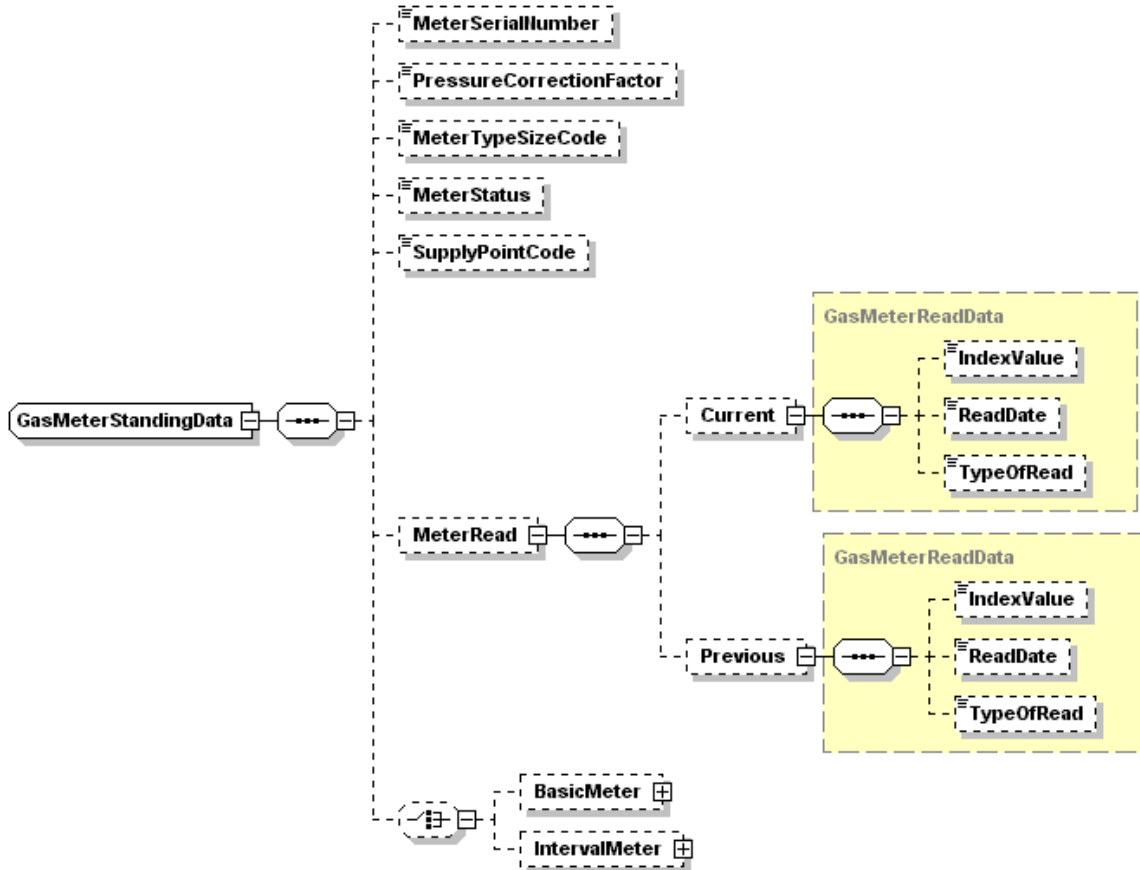

- “GasBasicMeterStandingData” used as “BasicMeter” element

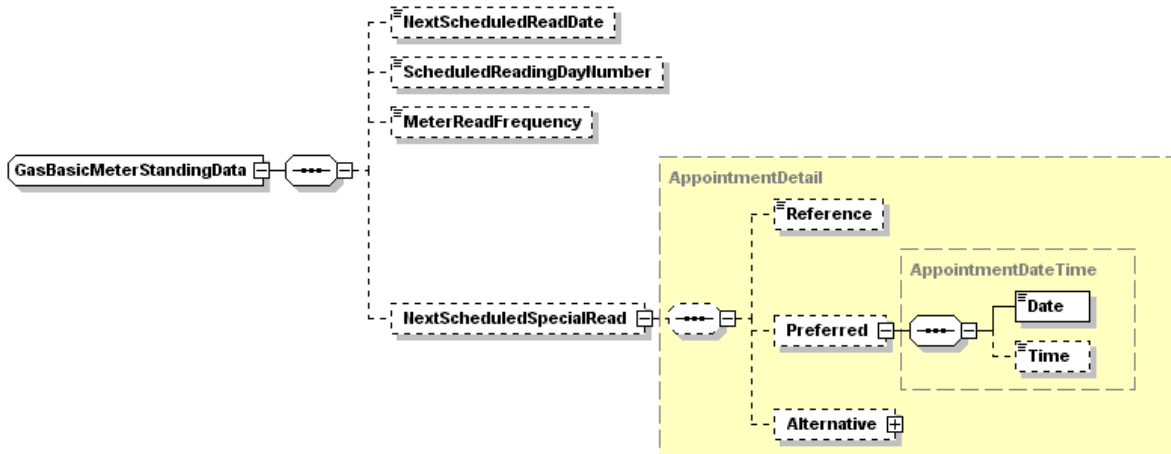

- “GasIntervalMeterStandingData” used as “IntervalMeter” element

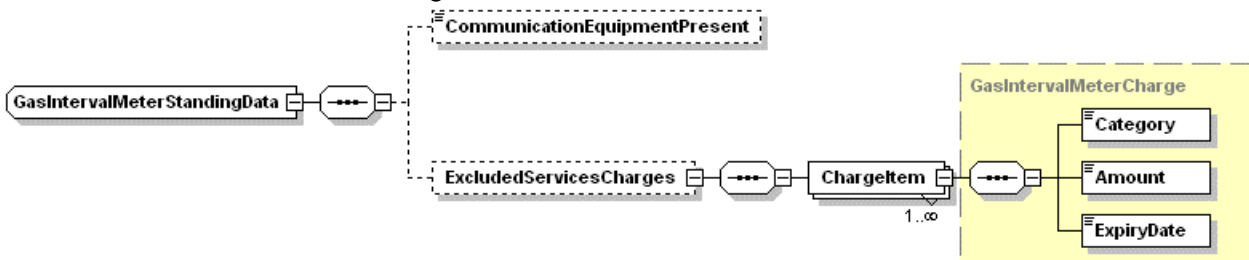

- "SiteData" element uses "ServicePoint" complex type defined in CustomerDetails file
- "AdditionalDataToFollow" uses simple true/false data type
- Defined "GasStandingDataUpdate" type based on "GasStandingData" and containing additional element "LastModifiedDateTime"
- Added the following gas specific derivations of the "NMITransactionBase" abstract type for use in transactions defined in MeterDataManagement file
- "GasMeterVerifyRequest" used in "MeterDataVerifyRequest" transaction

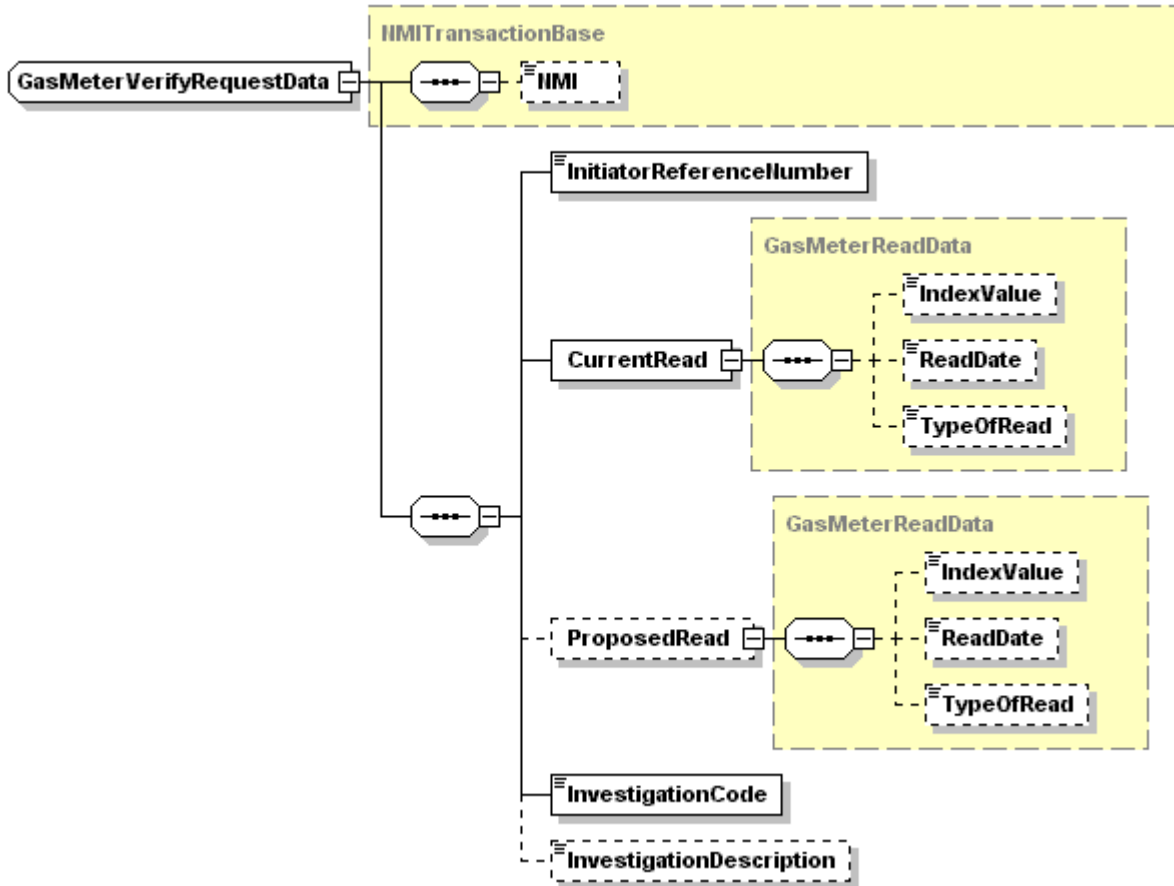

- “GasMeterVerifyResponse” for use in “MeterDataVerifyResponse” transaction

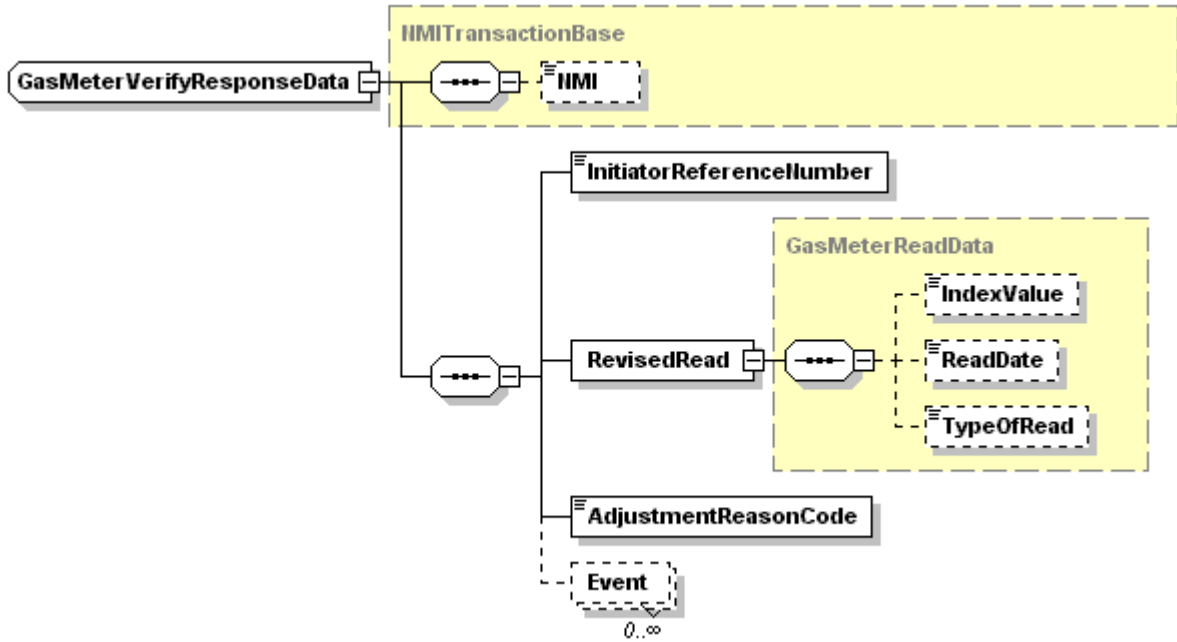

- “GasSingleHistoryRequestData” for use in “MeterDataHistoryRequest” transaction

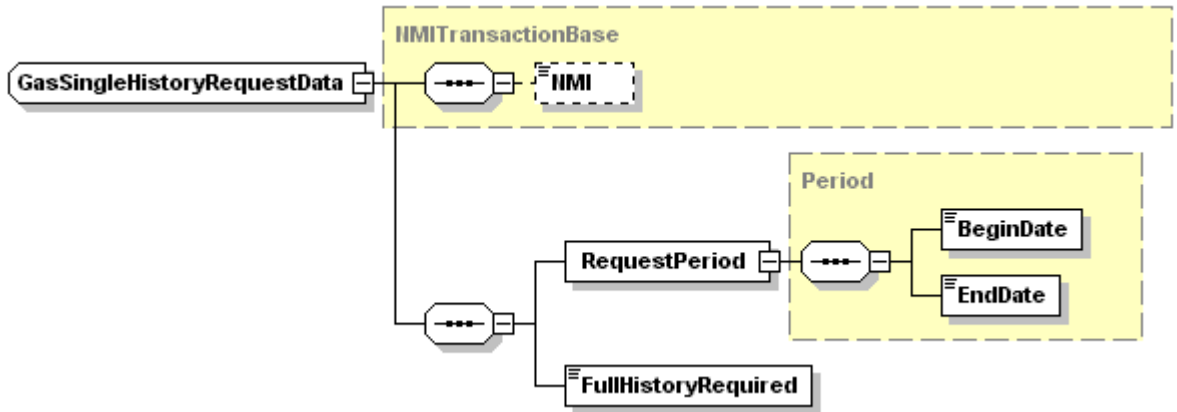

- Added the following Gas specific tranactions
- GasMeterNotification

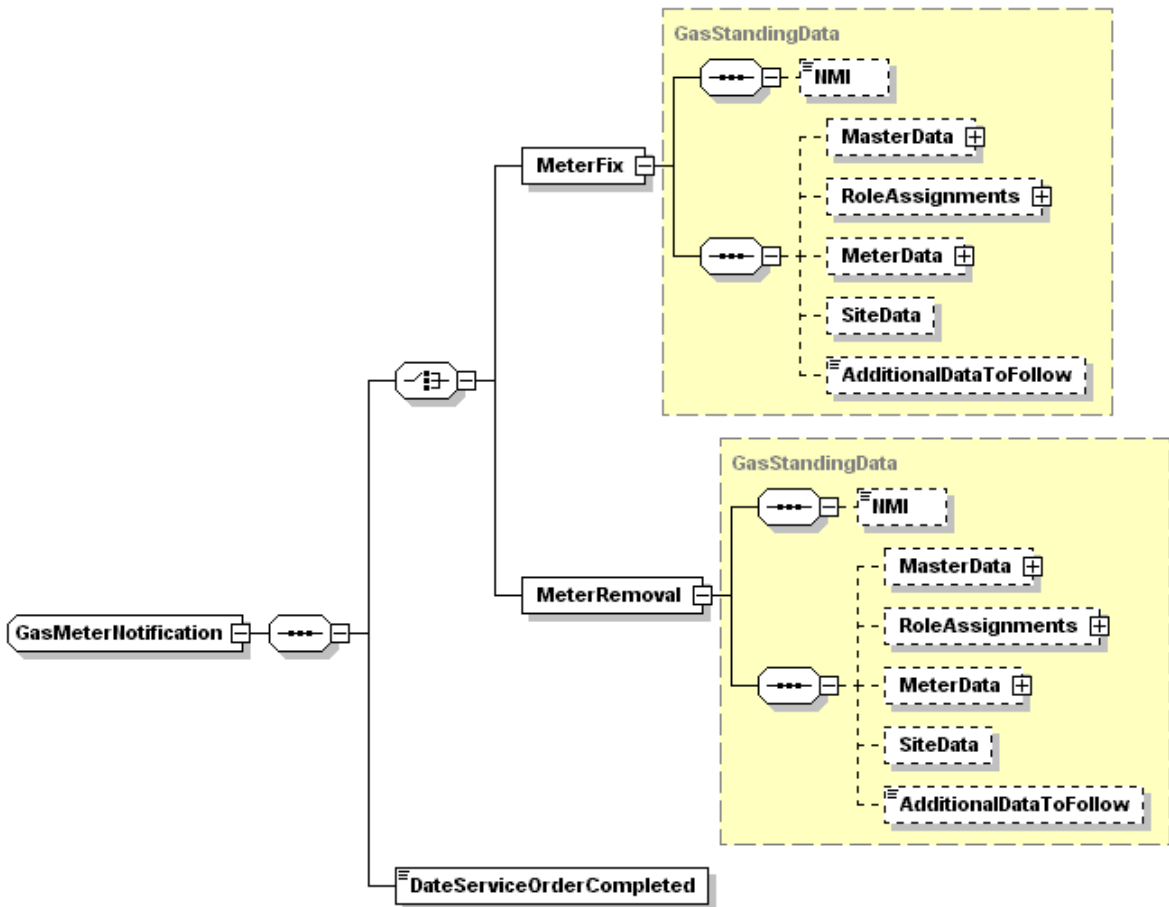

- MeteredSupplyPointsCountUpdate



3.14. Header

3.14.1. r8

- Removed MessageIdentifier
- Added transaction groups: FLTS, SORD, NETB, MTRD, CUST and NOTF
- TransactionPriority is now based on Priority instead of xsd:string.

3.14.2. r9

- Added transaction groups: SITE, FLDW

3.15. MDMTReport

- No Change

3.16. MeterConfig

Note: This file was introduced in r8 and has been dropped from the schema because of implementing the MSATS 2 changes.

3.17. MeterDataManagement

- Added following transactions MeterDataVerifyRequest, MeterDataVerifyResponse, MeterDataHistoryRequest, MeterDataHistoryResponse, AccountCreationNotification, MeterConfigNotification, MeterDataMissingNotification.
- Optional element RecordCount is added to the MeterDataNotification transaction. Consequently, transaction version number becomes r9. The content of the transaction for MSATS remains the same, as the added optional element will not be used.

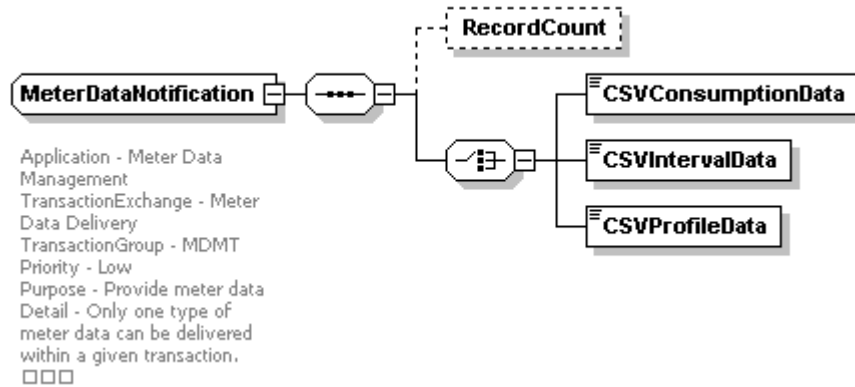

3.18. NetworkBilling

- Added transaction NetworkDUoSBillingNotification and updated the same to reflect the requirements for the ExcludedServicesCharges:

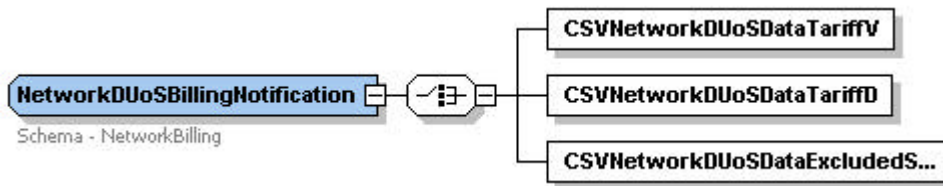

3.19. NMIDataAccess

- Definitions for complexTypes were added to define the NMISstandingDataUpdateNotification transaction.

3.20. Reports

- No change

3.21. ServiceOrder

- Modified the simpleType SpecialReadReasonCode and the complexTypes - ServiceOrderHeader, NewConnection, ServiceOrderRequest, ServiceOrderNotification, FieldWorkNotification. Also renamed element Line in SORDSpecialComments to CommentLine (see ServiceOrderRequest element below).

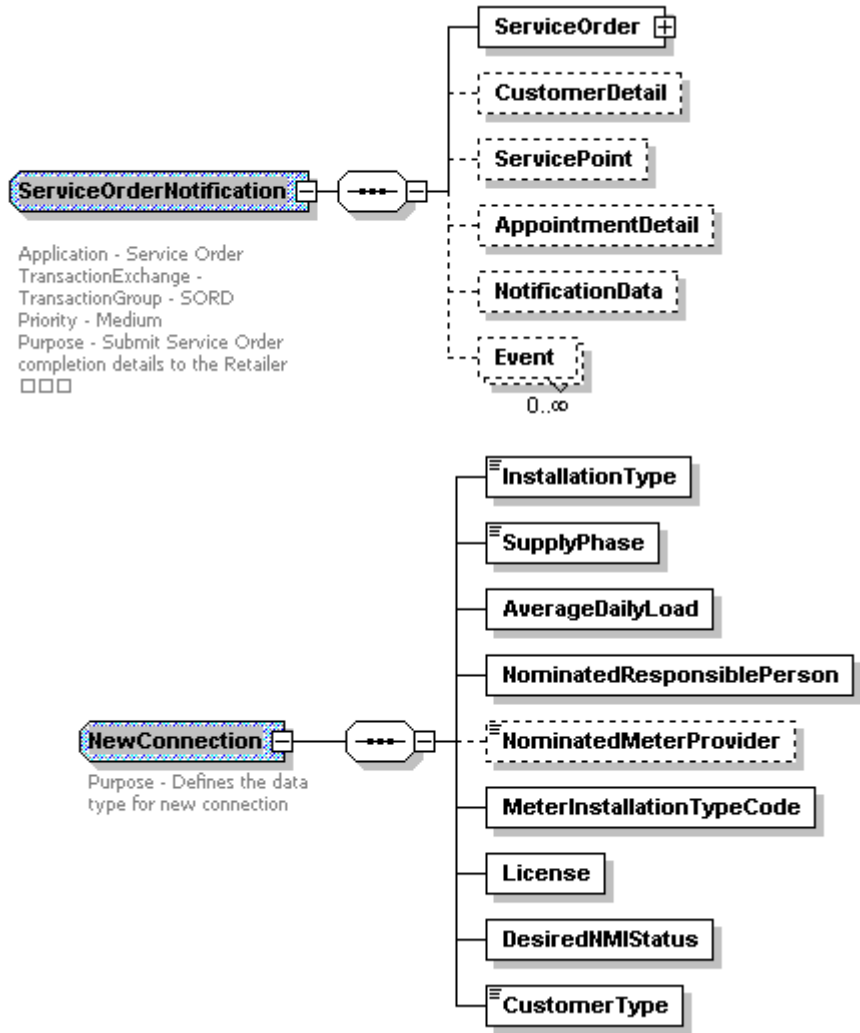

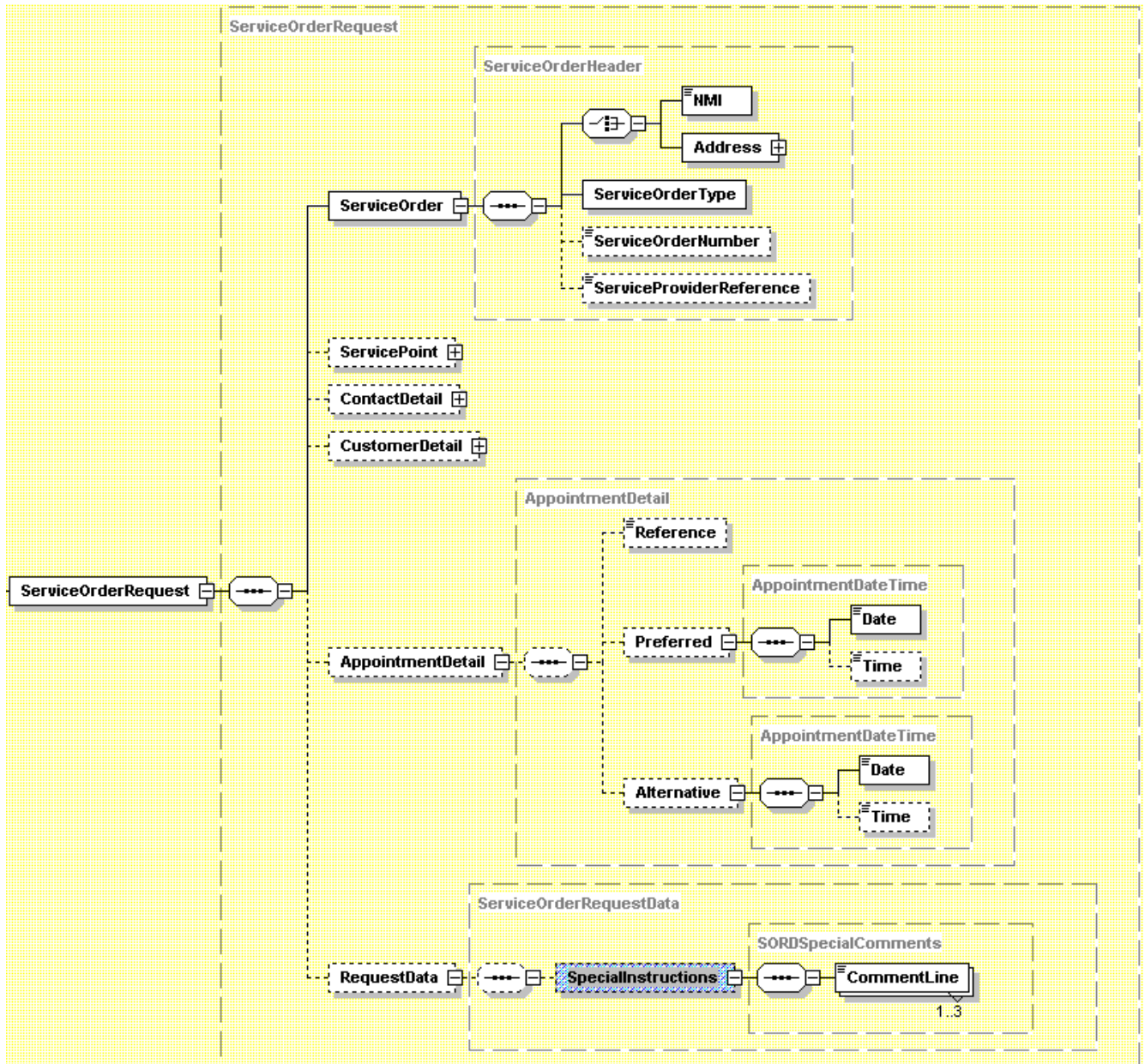

- Added complexType hierarchies ServiceOrderRequestData, ServiceOrderNotificationData, and ServiceOrderType. These hierarchies are not shown below.
- Also moved highest level fuel specific concrete derivations of the “ServiceOrderType”, “ServiceOrderDetails” and “ServiceOrderNotificationData” types from the fuel specific files to this file. Gas variants are:

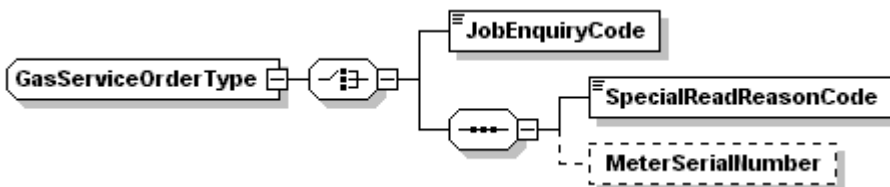

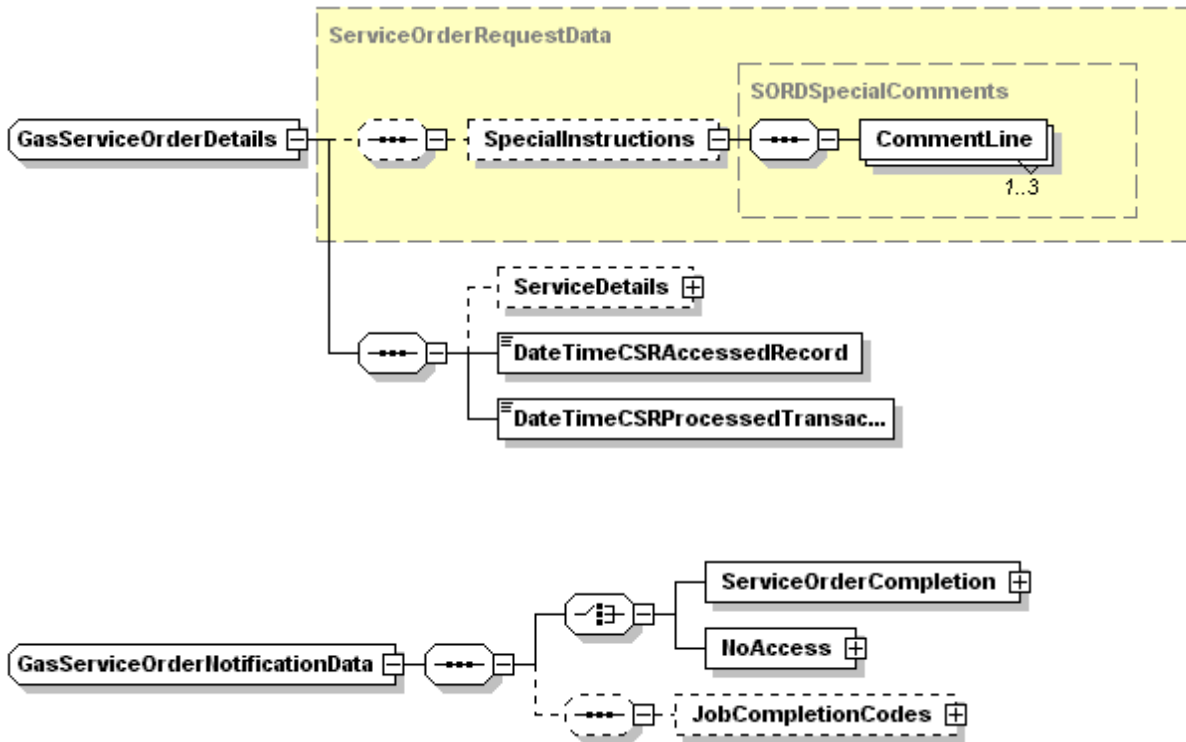

3.22. TableReplication

- Replaced simpleTypes with primitive data types.

3.23. Transactions

3.23.1. r8

- B2B transactions added.

3.23.2. r9

- Gas transactions added.

4. Validating the schema

Given the recommendations of using the MSXML4 and Xerces J 1.4.3. parsers, the schema was modified to be successfully validated by both parsers. The schemas were shuffled to comply with Xerces J “forward only” parser:

Type Name	Initially in File	Moved to File
AppointmentDateTime	Appointments_r9.xsd	Common_r9.xsd
AppointmentDetail	Appointments_r9.xsd	Common_r9.xsd
AppointmentStatus	ServiceOrder_r9.xsd	Appointments_r9.xsd
ReleasIdentifier and all value types	Common_r9.xsd	Events_r6.xsd
RecordCount	NetworkBilling_r9.xsd	Common_r9.xsd
Period	NetworkBilling_r9.xsd	Common_r9.xsd
Amount	NetworkBilling_r9.xsd	Common_r9.xsd
UpdateStatus	CustomerDetails_r9.xsd	Common_r9.xsd
HazardCode	ServiceOrder_r9.xsd	Common_r9.xsd
MeterSiteName	Restored	Common_r9.xsd
MeterEstablishmentInstructions	Restored	Common_r9.xsd

Type Name	Initially in File	Moved to File
ServicePoint	CustomerDetails_r9.xsd	Gas_r9.xsd
Re-ordered types defined	Gas_r9.xsd	Gas_r9.xsd

A new type HazardCodeWithAttribute was added to the Gas_r9.xsd to eliminate the error: "The base type used to derive anonymous complexType for the complexContent must be of the complexType".

5. Disclaimer

Independent Confirmation - ASWG strongly advises that all information or material contained in this file should be independently verified before use. The user may need to inform themselves of other relevant information or business processes.

No Warranty – Neither ASWG nor any of ASWG's advisers, consultants or other contributors to this file (or their respective associated companies, businesses, partners, directors, officers or employees) make any representation or warranty, express or implied, as to the currency, accuracy, reliability or completeness of the information or material contained in, referred to in or accessed from this file.

No Liability - To the maximum extent permitted by law, neither ASWG nor any of its advisers, consultants or other contributors to this file (or their respective associated companies, businesses, partners, directors, officers or employees) shall have any liability (whether arising from negligence or otherwise) in respect of the use of the file or information contained in, referred to in or accessed from this file (including any reliance on the currency, accuracy, reliability or completeness of the information).