

**Schema Release Notes**  
**AseXML Schema Working Group**  
**Release r16**

## Document History

<b>Version</b>	<b>Date</b>	<b>Authors</b>	<b>Comments</b>
1.0	18/11/2004	Bhawna Kapoor	Initial draft

## Contents

Schema Release Notes.....	1
AseXML Schema Working Group .....	1
Release r16.....	1
Document History.....	2
Contents.....	3
1. Introduction .....	4
2. Change Requests .....	4
3. Schema Manifest .....	4
4. File Change Summary .....	5
4.1 Acknowledgements.....	5
4.2 aseXML .....	5
4.3 BAR.....	5
4.4 BulkDataTool .....	5
4.5 CATSReport .....	5
4.6 CATSTableReplication .....	5
4.7 ClientInformation .....	5
4.8 Common.....	5
4.9 CustomerDetails.....	5
4.10 CustomerTransfer.....	5
4.11 Electricity.....	5
4.12 Enumerations .....	5
4.13 Events .....	5
4.14 Faults.....	5
4.15 Gas .....	5
4.16 Header.....	6
4.17 MDMTReport .....	7
4.18 MeterDataManagement .....	7
4.19 NetworkBilling .....	7
4.20 NMIDataAccess.....	7
4.21 NOSAssessment .....	7
4.22 NOSBooking.....	13
4.23 NOSCommon .....	15
4.24 NOSEquipment .....	15
4.25 Reports.....	16
4.26 ServiceOrder .....	16
4.27 TableReplication .....	16
4.28 Transactions.....	16
5. Disclaimer .....	16

## 1. Introduction

Version r16 of the schema is developed from r15. This document identifies the changes made to the schema for this release.

## 2. Change Requests

The following ASWG Change Requests have been included in this schema release:

CR#	Description
18	Modified the schema to add a new aseXML element called NetworkID to GasMasterStandingData.
22	Modified the existing schema to include additional Network Outage Scheduler (NOS) transactions.

## 3 Schema Manifest

The table below shows the schema files included in this release. Files that have been added, removed or modified for this release are marked.

File names	Added	Removed	Modified
Acknowledgements_r15.xsd			
aseXML_r16.xsd			X
BAR_r15.xsd			
BulkDataTool_r15.xsd			
CATSReports_r15.xsd			
CATSTableReplication_r15.xsd			
ClientInformation_r15.xsd			
Common_r15.xsd			
CustomerDetails_r15.xsd			
CustomerTransfer_r15.xsd			
Electricity_r15.xsd			
Enumerations.xsd			
Events_r16.xsd			X
Faults_r15.xsd			
Gas_r16.xsd			X
Header_r15.xsd			
MDMTRReport_r15.xsd			
MeterDataManagement_r15.xsd			
NetworkBilling_r15.xsd			
NMIDataAccess_r15.xsd			
NOSAssessment_r16.xsd	X		
NOSBooking_r16.xsd			X
NOSCommon_r16.xsd			X
NOSEquipment_r16.xsd			X
Reports_r15.xsd			
ServiceOrder_r15.xsd			
TableReplication_r15.xsd			
Transactions_r16.xsd			X
No of files added	1		
No of files removed		0	
No of files modified			7
Total No of files			28

## 4 File Change Summary

### 4.1 *Acknowledgements*

- No change.

### 4.2 *aseXML*

- Changed aseXML namespace to urn:aseXML:r16.
- Changed the names of all affected files to new filenames.
- Added an include statement for NOSAssessment.

### 4.3 *BAR*

- No change.

### 4.4 *BulkDataTool*

- No change.

### 4.5 *CATSReport*

- No change.

### 4.6 *CATSTableReplication*

- No change.

### 4.7 *ClientInformation*

- No change.

### 4.8 *Common*

- No change.

### 4.9 *CustomerDetails*

- No change.

### 4.10 *CustomerTransfer*

- No change.

### 4.11 *Electricity*

- No change.

### 4.12 *Enumerations*

- No change.

### 4.13 *Events*

- No change.

### 4.14 *Faults*

- No change.

### 4.15 *Gas*

- Added an optional Element NetworkID to GasMasterStanding data.

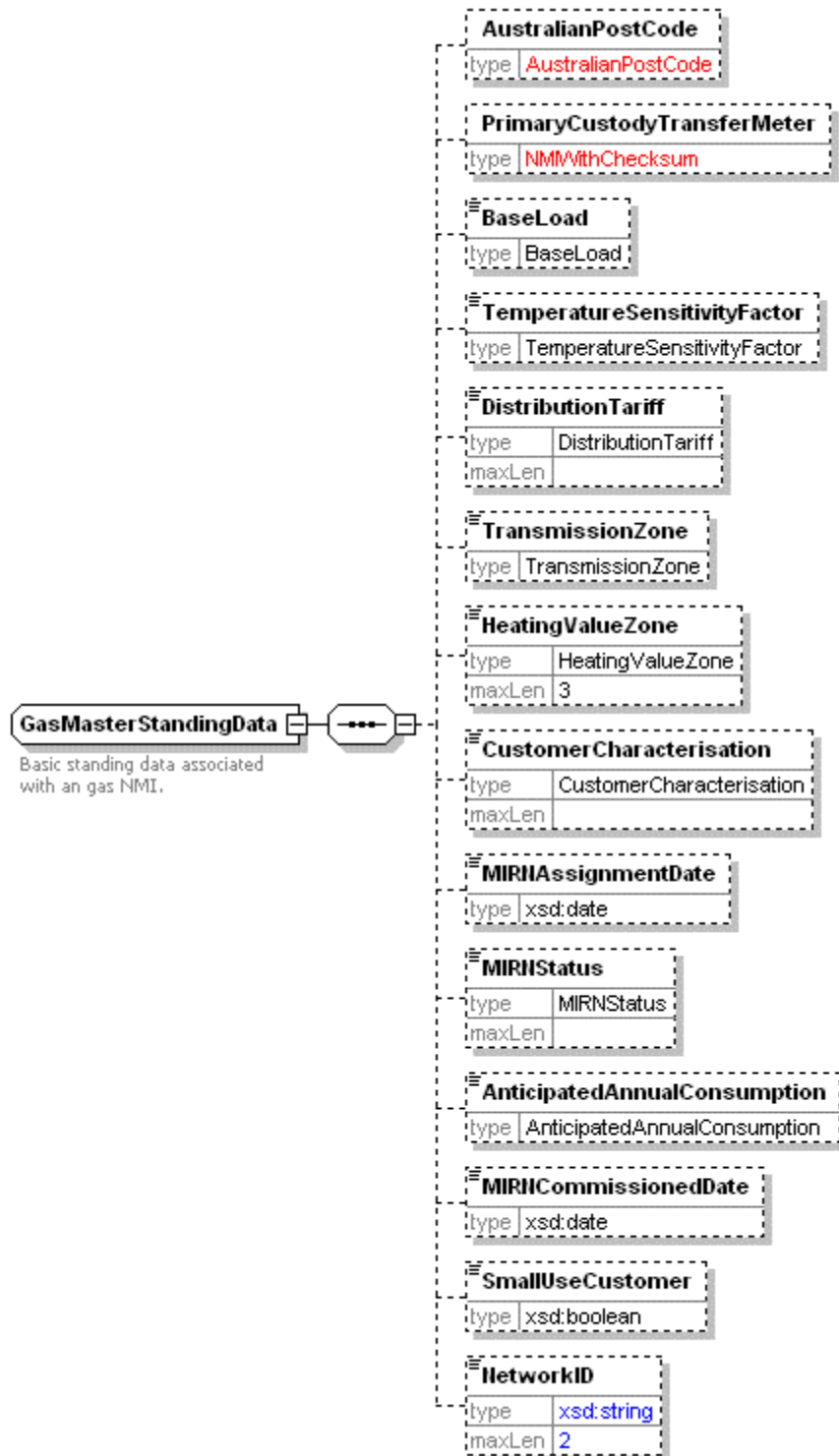

The following transactions will be affected by this change.:  
**MeterFix, MIRNStatusUpdate, CATSDataRequest and CATSChangeRequest.**

- Updated the version of MeterFix and MIRNStatusUpdate to r16.

#### 4.16 Header

- No change.

#### 4.17 MDMTReport

- No change.

#### 4.18 MeterDataManagement

- No change.

#### 4.19 NetworkBilling

- No change.

#### 4.20 NMIDataAccess

- No change.

#### 4.21 NOSAssessment

This is a new schema file that includes following:

- Added a new transaction NOSInfoResponse

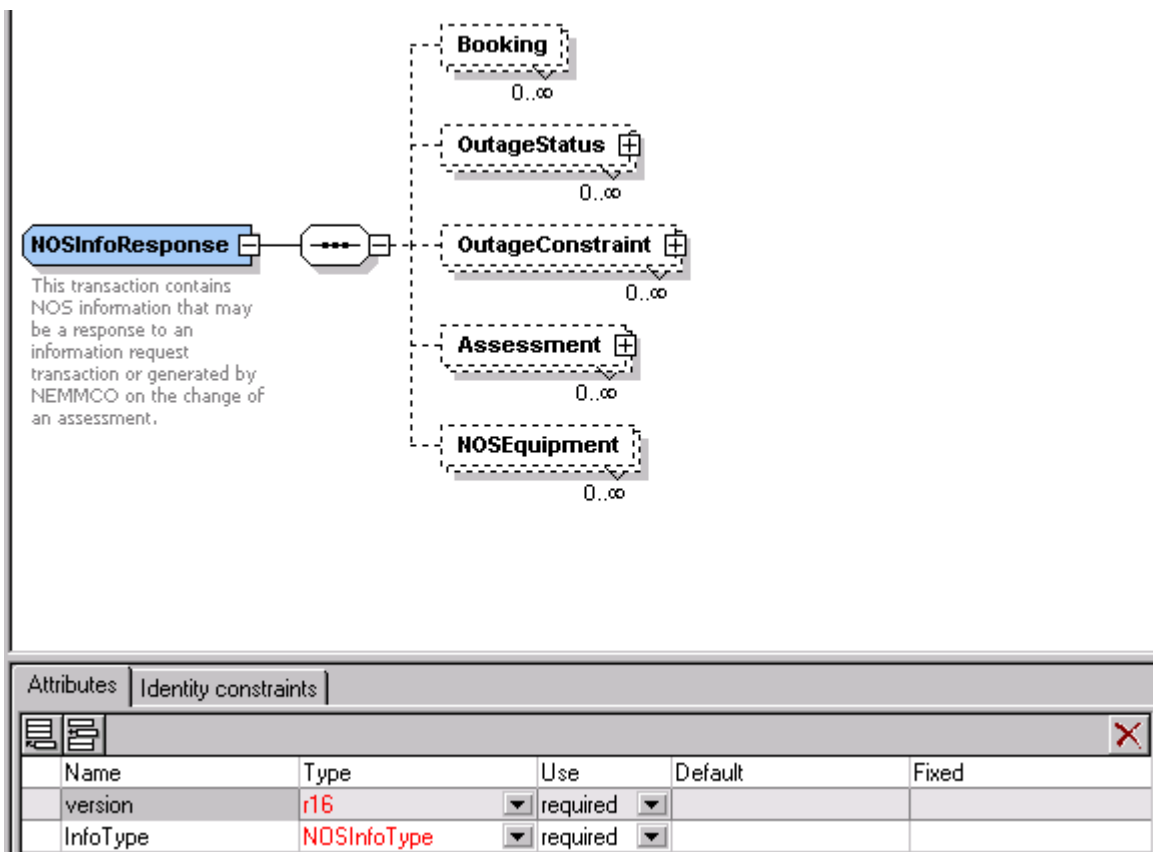

- Added following new complexType elements:
  - a. OutageStatusType

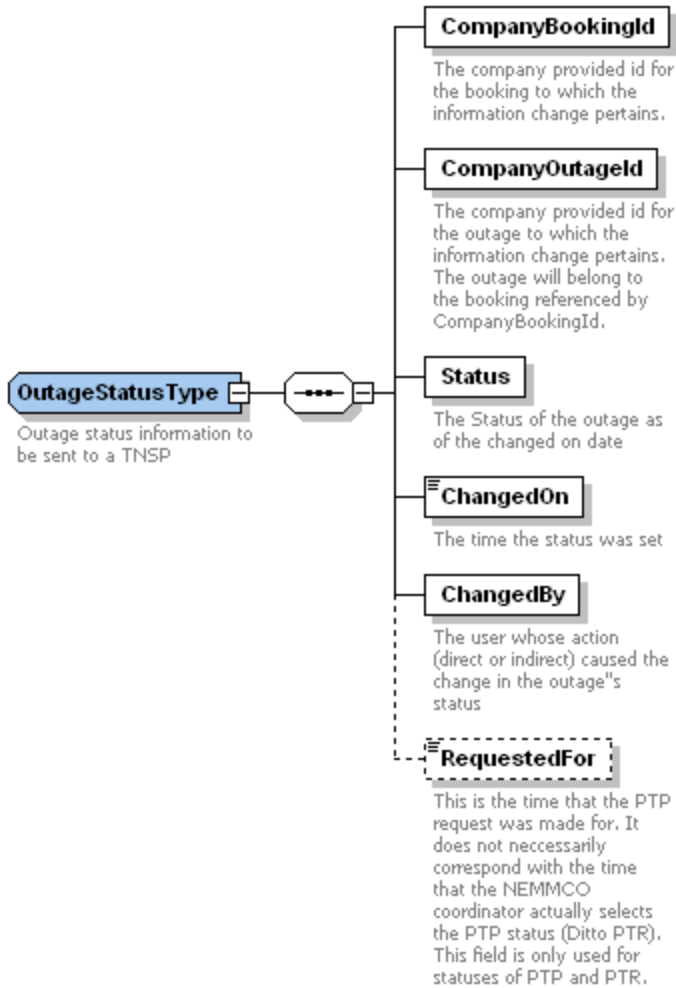



b. OutageConstraintType

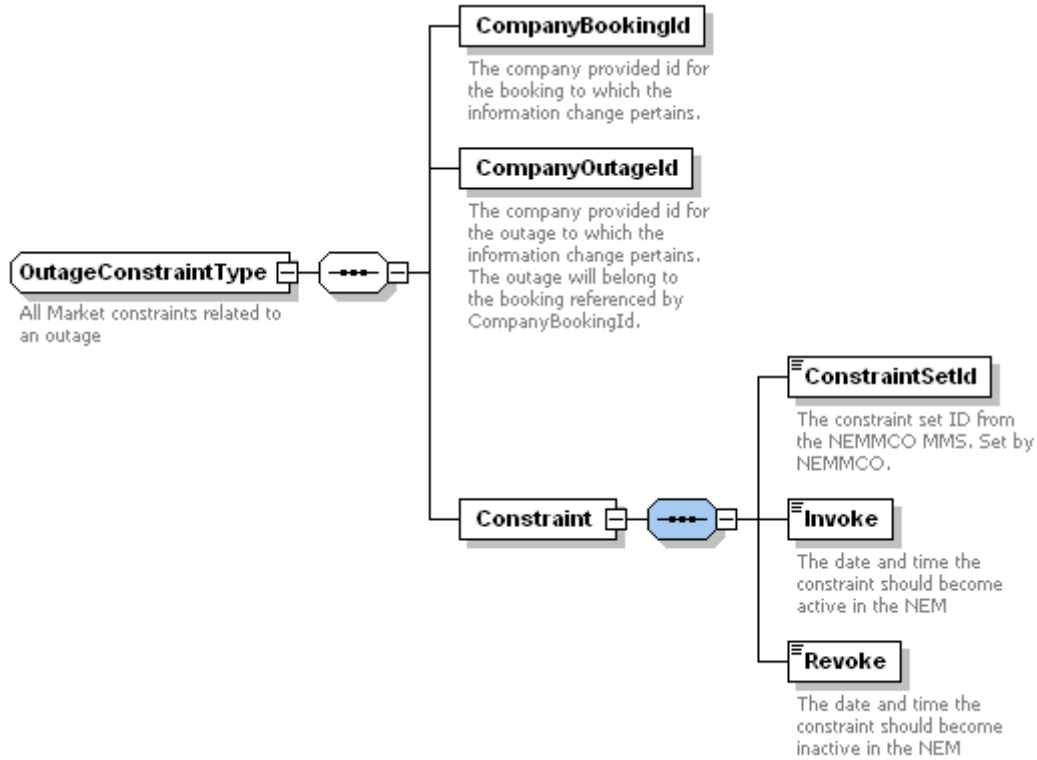

c. NOSAssessmentNoteType

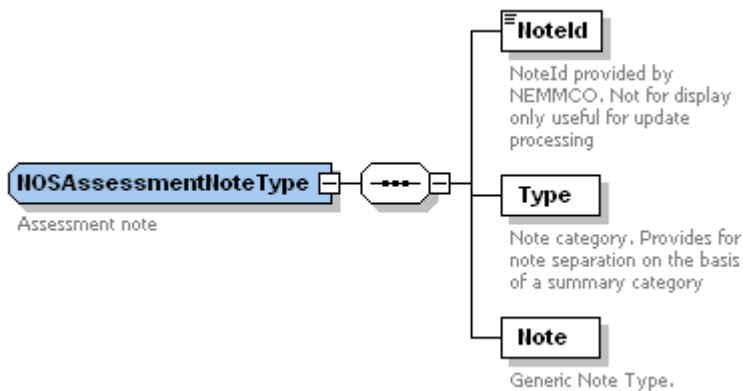

d. NOSIssueType

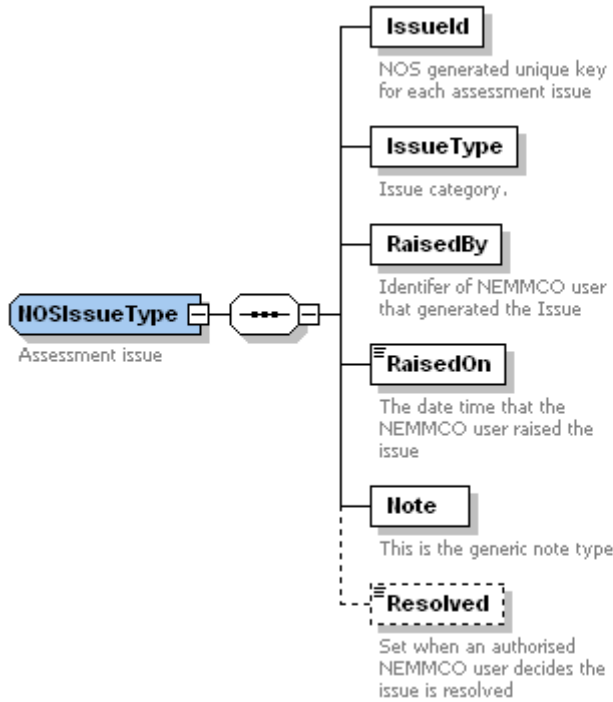

e. NOSConstraintType

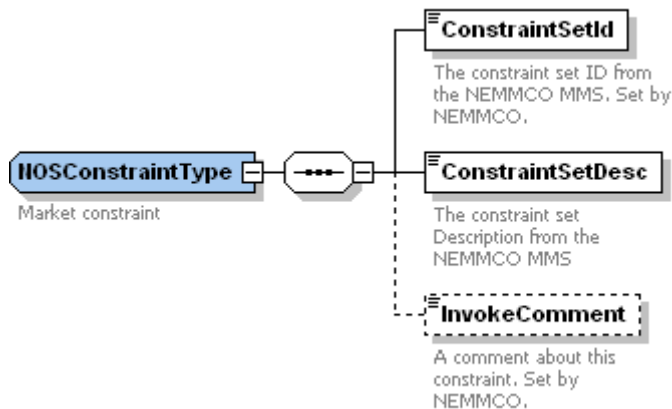

f. NOSRiemnsLimitType

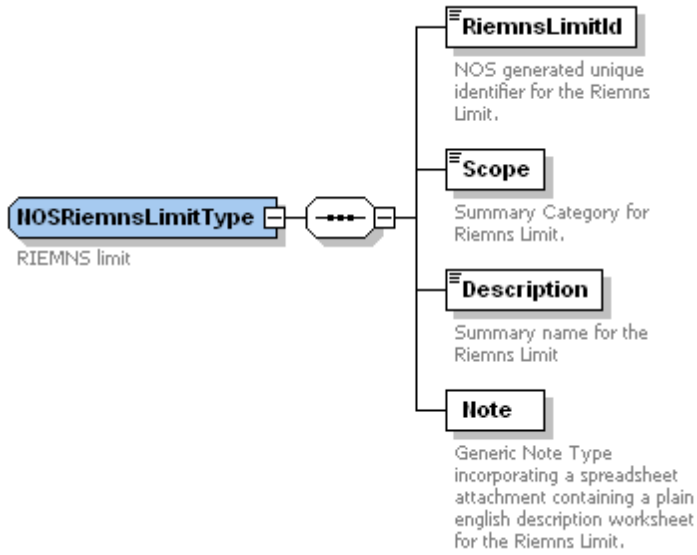

g. NOSAssessmentType

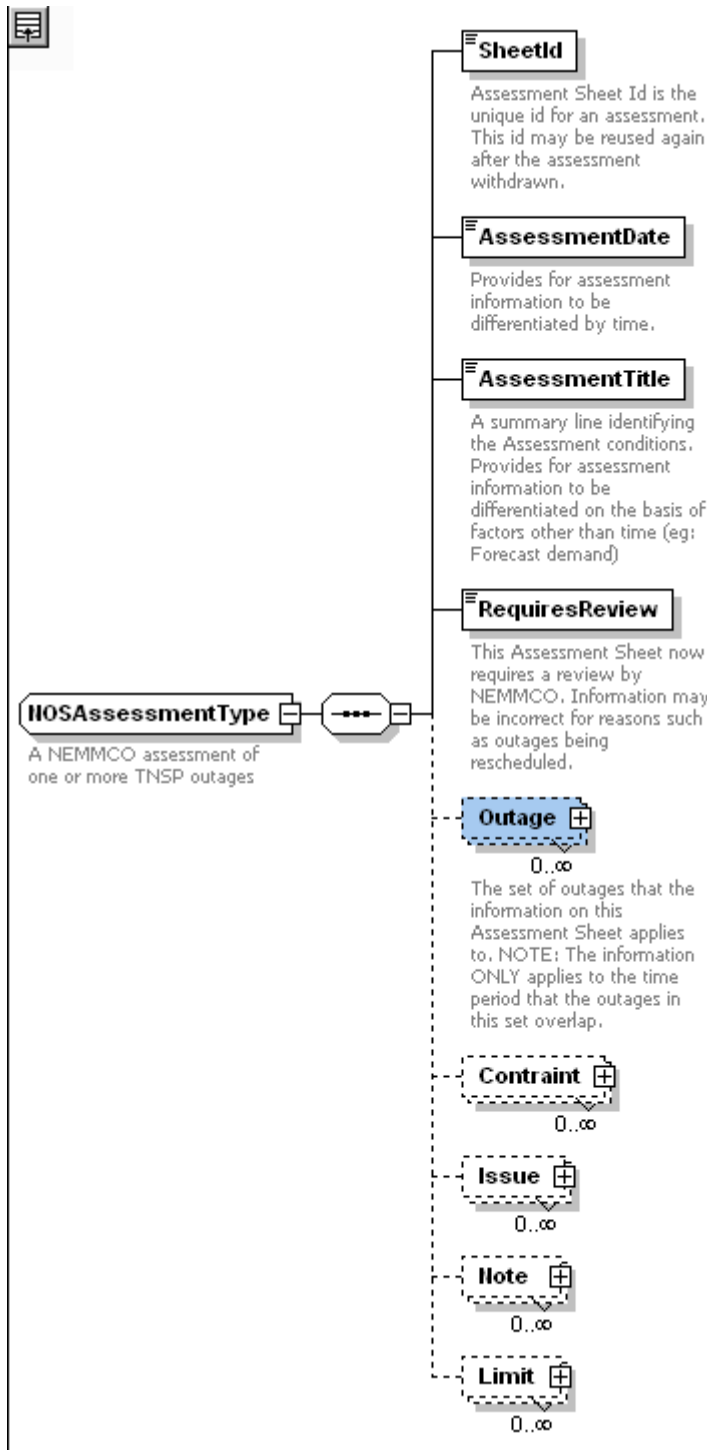

The complexType child element Outage of NOSAssessmentType is defined as follows:

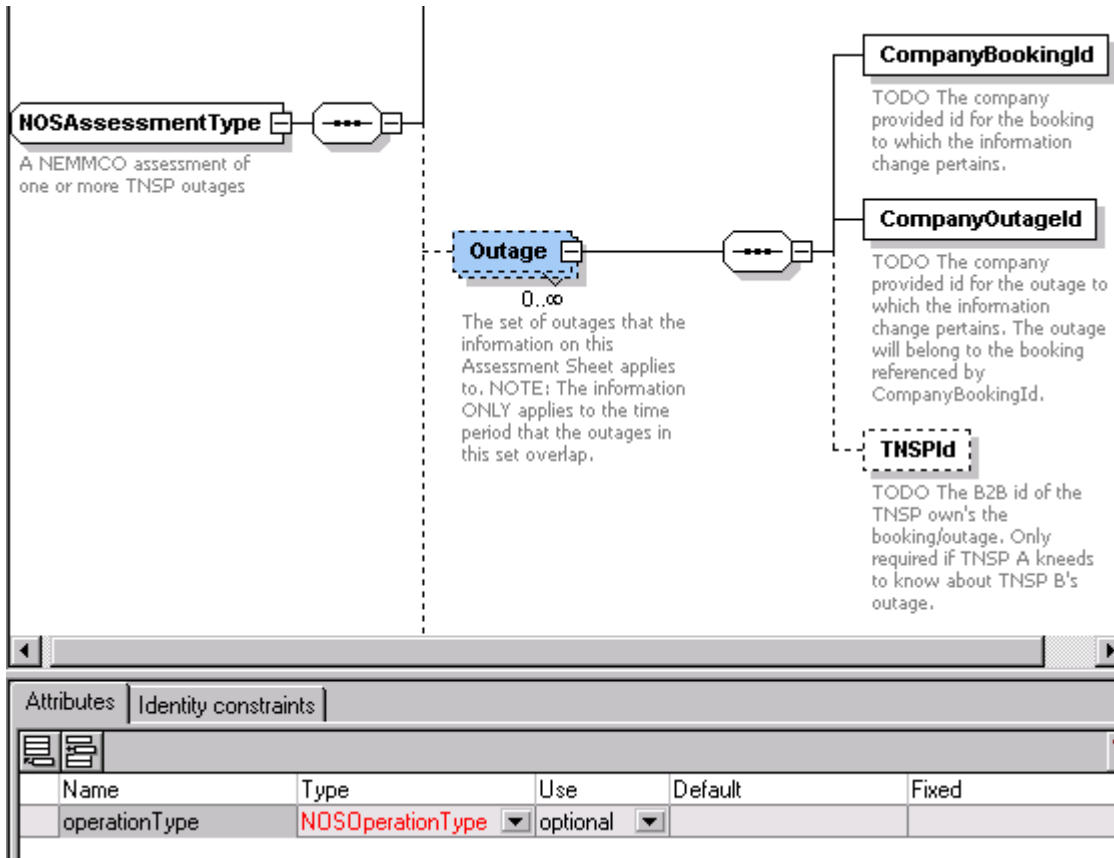

### 4.22 NOSBooking

- ComplexType NOSBookingRequest replaced by NOSBookingSubmission. NOSBookingSubmission has r16 version attribute.

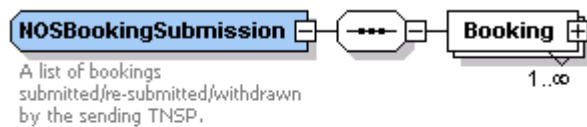

Name	Type	Use	Default	Fixed
version	r16	required		

- Added two new complexTypes:
  - NOSBookingInfoRequest

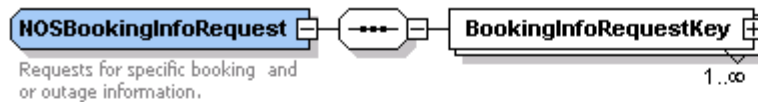

Attributes		Identity constraints			
Name	Type	Use	Default	Fixed	
version	r16	optional			

- BookingInfoRequestKey

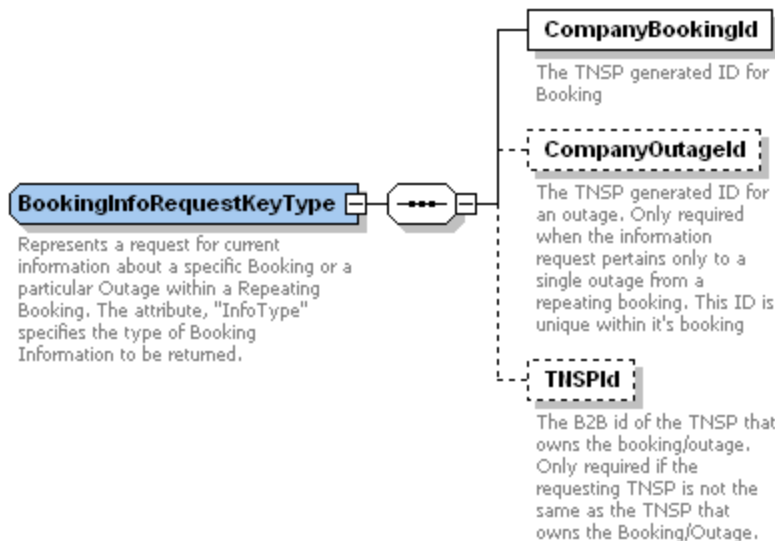

- Updated the element BookingType as follows:
  - Added a new element TNSPId
  - Added an optional attribute changedBy
  - Changed operationType attribute from "required" to "optional"

- Updated the element CompanyNoteType as follows:
  - Added an optional attribute changedBy
  - Changed operationType attribute from “required” to “optional”
- Updated the element NOSOutageType as follows:
  - Added an optional attribute changedBy
  - Changed operationType attribute from “required” to “optional”

**4.23 NOSCommon**

- Updated the element NoteType to include an optional attribute changedBy.
- Extended the enumeration EnumCompanyNoteType by adding a new value “Isolation Points”.
- Defined new enumerated lists as follows:
  - EnumOutageStatusType
  - EnumAssessmentIssueType
  - EnumAssessmentNoteType
- Updated NoteType to include two new optional elements:
  - CreatedBy
  - CreatedOn
- Added two new simple type elements:
  - NEMMCOIssuedType
  - NOSUserIdType

**4.24 NOSEquipment**

- Updated the version attribute for NOSEquipmentSubmission to r16.
- Added a new complexType NOSEquipmentInfoRequest.

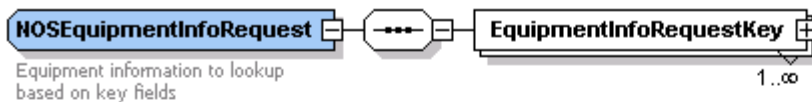

Attributes		Identity constraints			
Name	Type	Use	Default	Fixed	
version	r16	required			

- Added a new complexType EquipmentInfoRequestKeyType.

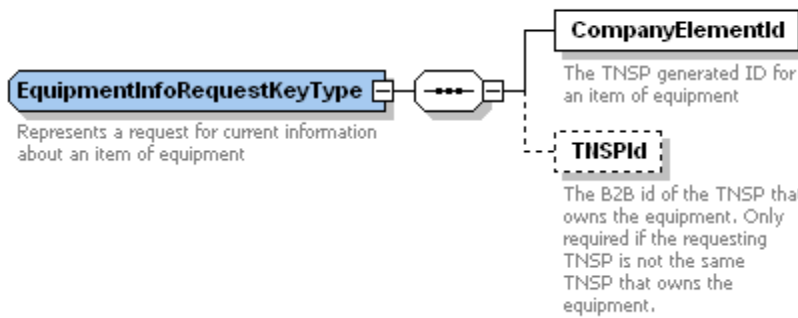

- Updated the element EquipmentBaseType to include the following new elements:
  - NEMMCOName
  - ValidatedBy
  - TNSPId
- Changed the attribute operationType (in EquipmentBaseType) from “required” to “optional”.
- Updated the element NOSStationType to include the following new elements:
  - NEMMCOAbbrev
  - Region
- Renamed the element NOSBreakingResistorType to NOSBrakingResistorType.

#### 4.25 Reports

- No change.

#### 4.26 ServiceOrder

- No change.

#### 4.27 TableReplication

- No change.

#### 4.28 Transactions

- Added following new transactions:
  - NOSInfoResponse
  - NOSBookingSubmission
  - NOSBookingInfoRequest
  - NOSBookingResponse
  - NOSEquipmentInfoRequest
- Removed transaction NOSBookingRequest.

## 5 Disclaimer

Independent Confirmation - ASWG strongly advises that all information or material contained in this file should be independently verified before use. The user may need to inform themselves of other relevant information or business processes.

No Warranty – Neither ASWG nor any of ASWG’s advisers, consultants or other contributors to this file (or their respective associated companies, businesses, partners, directors, officers or employees) make any representation or warranty, express or implied, as to the currency, accuracy, reliability or completeness of the information or material contained in, referred to in or accessed from this file.



No Liability - To the maximum extent permitted by law, neither ASWG nor any of its advisers, consultants or other contributors to this file (or their respective associated companies, businesses, partners, directors, officers or employees) shall have any liability (whether arising from negligence or otherwise) in respect of the use of the file or information contained in, referred to in or accessed from this file (including any reliance on the currency, accuracy, reliability or completeness of the information).