

Schema Release Notes

AseXML Schema Working Group

Release r10

Document History

Version	Date	Authors	Comments
r10	28/01/2003	Nada Reinprecht	Bug fixes in ElectricityStandingData; Extensions of Meter Reports and CATSNotification transaction; Additional rows

Contents

Schema Release Notes	1
AseXML Schema Working Group	1
Release r10	1
Document History	2
Contents	3
1. Introduction	3
2. Schema Manifest	4
3. File Change Summary	4
3.1. Acknowledgements	4
3.2. Appointments	4
3.3. aseXML	4
3.4. BulkDataTool	5
3.5. CATSReport	5
3.6. CATSTableReplication	5
3.7. ClientInformation	6
3.8. Common	6
3.9. CustomerDetails	6
3.10. CustomerTransfer	6
3.11. Electricity	7
3.12. Events	7
3.13. Faults	7
3.14. Gas	7
3.15. Header	7
3.16. MDMTReport	7
3.17. MeterConfig	8
3.18. MeterDataManagement	8
3.19. NetworkBilling	8
3.20. NMIDataAccess	8
3.21. Reports	8
3.22. ServiceOrder	9
3.23. TableReplication	9
3.24. Transactions	9
4. Disclaimer	9

1. Introduction

R10 version of the schema is developed from r9 version 1.5 as result of NEMMCO schema change request.

The summary of schema changes are as follows:

- Street type RETURN removed from AustralianStreetType
- TestResultAccuracy allows for negative values
- Status in ElectricityMeter is not nillable
- Tables CATS_NETWORKTARIFF_CODES and CATS_STANDING_DATA_ACCESS_RULES included in C1 report
- Metering reports RM11, RM16, RM19, RM22 and RM21 enhanced based on new requirements
- Report parameters extended with row limit
- CATSNotification extended
- Row of the CATS_STREAMLINED_CR_CODES table added

2. Schema Manifest

The table below summarises the various schema releases and files included within those releases. The release identifier in the file name reflects when the file was last modified. All files included in a release are marked with a black tick. A cross means the file was removed from the release. The following legend is applied to the table:

- Files modified between r7 patch1 and r10 are marked with plum tick.
- Files modified between r9 and r10 are marked with purple tick.

File names	r10
Acknowledgements_r9.xsd	
Appointments_r10.xsd	✓
AseXML_r10.xsd	✓
BulkDataTool_r9	
CATSReports_r9.xsd	
CATSTableReplication_r10.xsd	✓
ClientInformation_r10.xsd	✓
Common_r10.xsd	✓
CustomerDetails_r10.xsd	✓
CustomerTransfer_r10.xsd	✓
Electricity_r10.xsd	✓
Events_r10.xsd	✓
Faults_r8.xsd	
Gas_r10.xsd	✓
Header_r9.xsd	
MDMTRReport_r10.xsd	✓
MeterDataManagement_r9.xsd	
NetworkBilling_r9.xsd	
NMIDataAccess_r9.xsd	
Reports_r10.xsd	✓
ServiceOrder_r10.xsd	✓
TableReplication_r10.xsd	✓
Transactions_r9.xsd	
Number of files included	23

3. File Change Summary

The section identifies and lists any changes between the various versions of the schema files and highlights any issues.

3.1. Acknowledgements

- No change

3.2. Appointments

- AppointmentRequest and AppointmentResponse transactions change version attribute to r10 as result of the change in the address.

3.3. aseXML

- Changed aseXML namespace to aseXML:r10
- Changed names of included files affected by r10

3.4. BulkDataTool

- No change

3.5. CATSReport

- No change

3.6. CATSTableReplication

- Following rows added:
 - CATSNetworkTariffCodeRow and
 - CATSStandingDataAccessRuleRow.
 - CATSStreamlinedCRCodesRow

The version number for the rows set to r10.

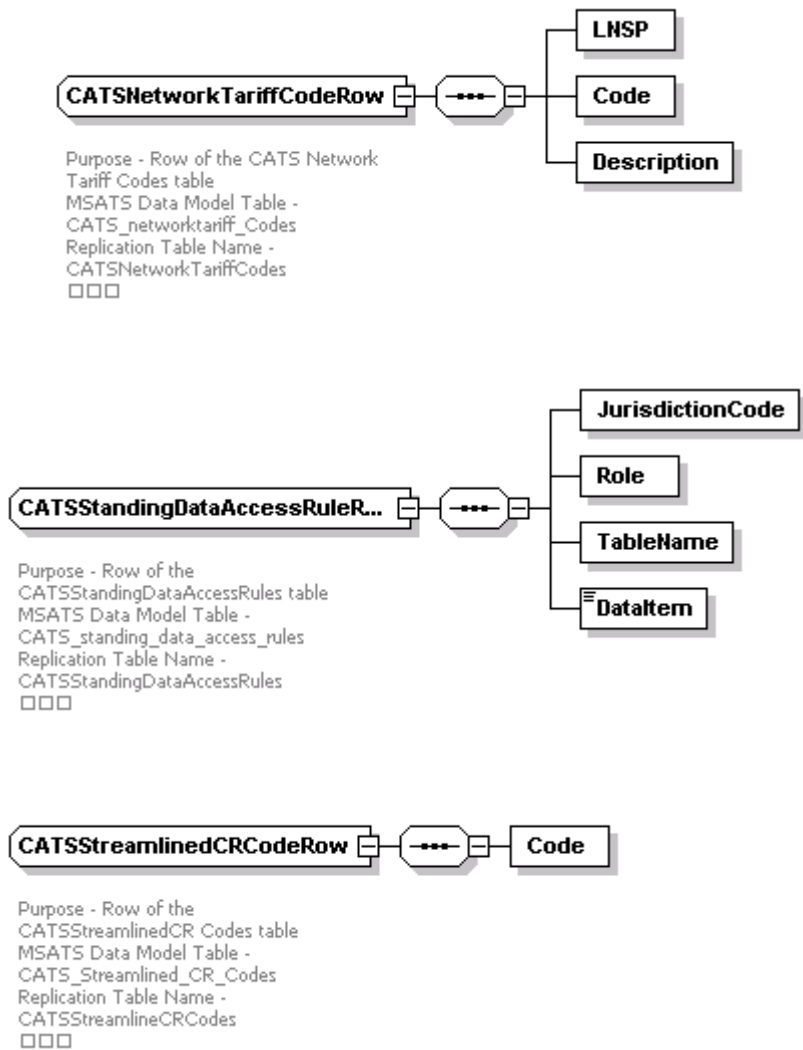

- SiteName, NetworkTariffCode and EstablishmentInstructions removed from ElectricityNMIMeterGroup.
- The version attribute on the ElectricityNMIMeterRow, ElectricityNMIMeterRowBDT and ElectricityCATSChangeRequestNMIMeterRow set to r10

- Version attribute of the ElectricityNMIMeterRegisterRow made optional

3.7. ClientInformation

- Street type RETURN removed

3.8. Common

- MeterTestResultAccuracy allows for negative values
- MeterSiteName and MeterEstablishmentInstructions types removed

3.9. CustomerDetails

- CustomerDetailsNotification transaction upgraded to r10 as result of change in address

3.10. CustomerTransfer

- CATSNotification transaction extended with JurisdictionCode, NMIClassificationCode and ObjectionEndDate elements
- CATSNotification transaction version number upgraded to r10

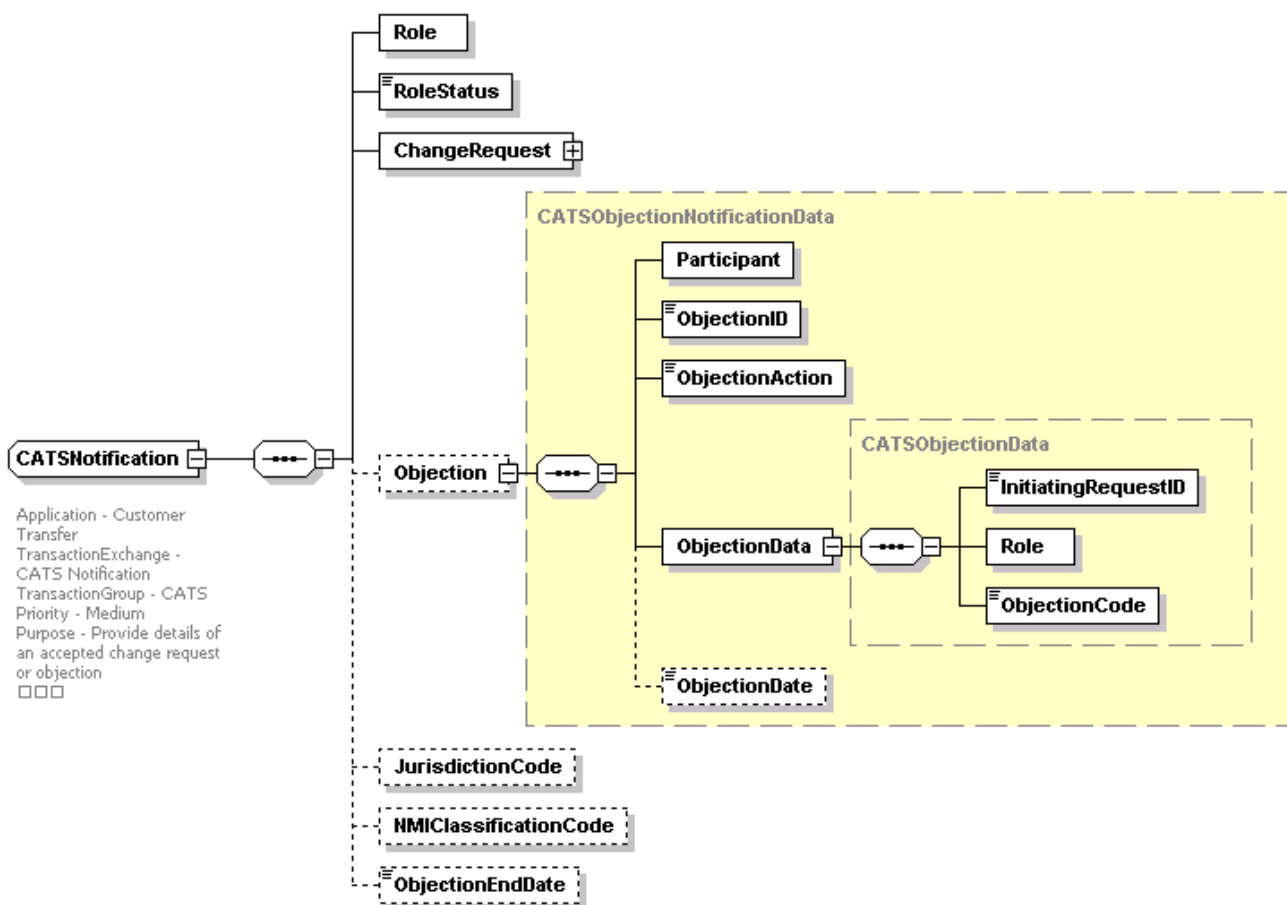

3.11. Electricity

- SiteName, NetworkTariffCode and EstablishmentInstructions removed from the ElectricityMeter type
- Removed nillable attribute from Status in ElectricityMeter
- Version attribute for ElectricityStandingData set to r10
- RegisterId in the ElectricityMeterRegisterDetail is not nillable

3.12. Events

- Added type for release r10

3.13. Faults

- No change

3.14. Gas

- GasStandingData changed the version attribute to r10 as result of change in the address.

3.15. Header

- No change

3.16. MDMTReport

- MDMTMissingDataReportParameters (RM11 report) extended with DataType and NMISelection elements. DataType can be: Interval or Consumption. NMISelection can obtain values: SecondTierNMIs or AIINMIs.
- MDMTSettlementCaseDateRangeReportParameters (RM16, RM19, RM22 reports) extended with SettlementRun element. SettlementRun may obtain the following values: RREV1, RREV2, SPECIAL, PRELIMINARY and FINAL.
- FRMP element made optional in the MDMTLevel2SettlementReconciliationReportParameters (RM21)
- Version attribute for the above report parameters set to r10

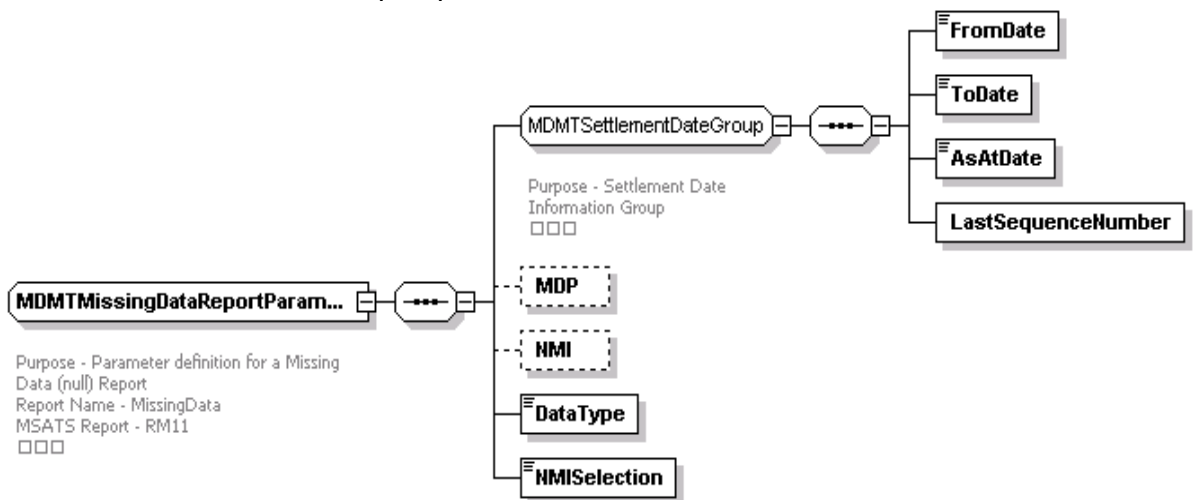

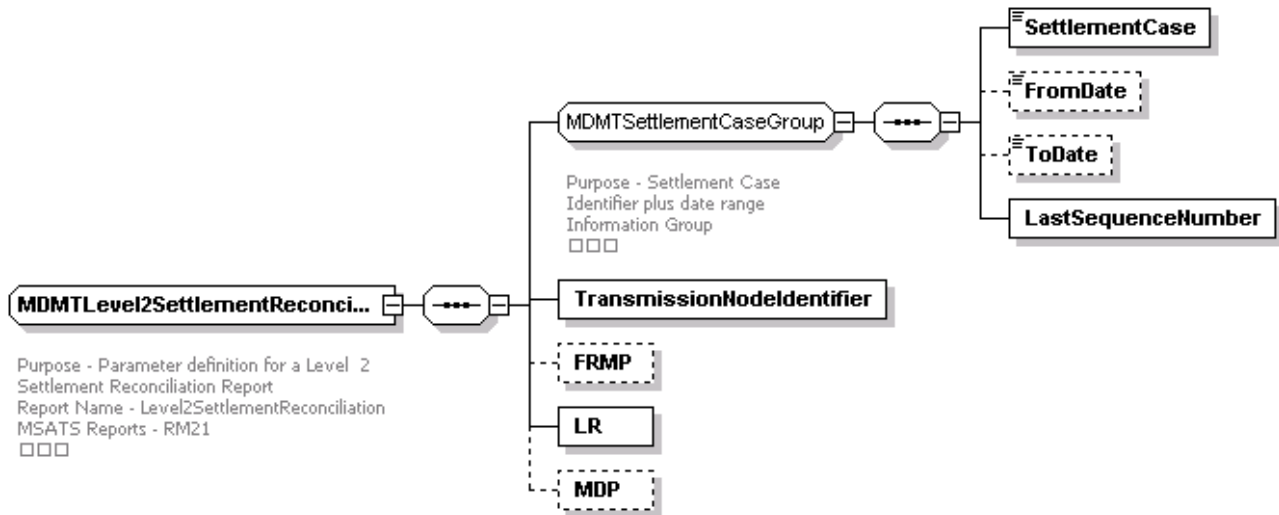
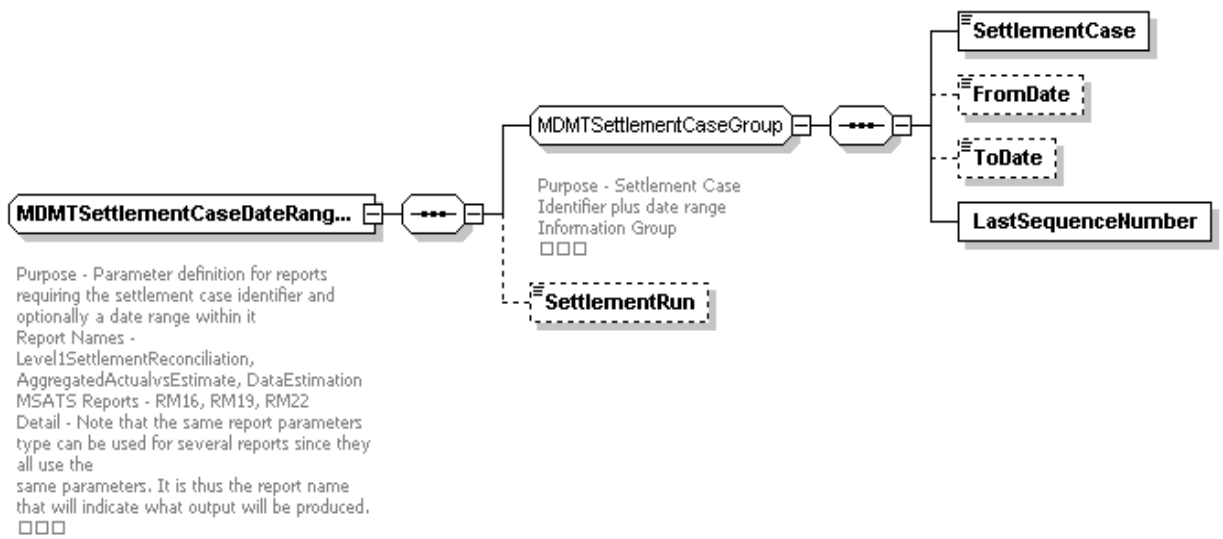

3.17. MeterConfig

Note: This file was introduced in r8 and has been dropped from the schema because of implementing the MSATS 2 changes.

3.18. MeterDataManagement

- No change

3.19. NetworkBilling

- No change

3.20. NMIDataAccess

- No change

3.21. Reports

- BaseReportParameters extended with MaximumRows optional element
- Version attribute for ReportRequest and ReportResponse transactions set to r10

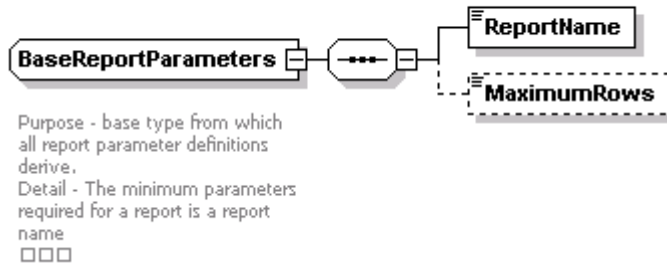

3.22. ServiceOrder

- ServiceOrderRequest and ServiceOrderNotification transactions change the version attributes to r10 as result of change in the address.
- Transactions SpecialReadRequest and SpecialReadResponse use the same type as ServiceOrderRequest and ServiceOrderResponse. Consequently, their version attribute is also upgraded to r10.

3.23. TableReplication

- Replication parameters extended with MaximumRows optional element
- Version attribute for ReplicationRequest and ReplicationNotification transactions set to r10

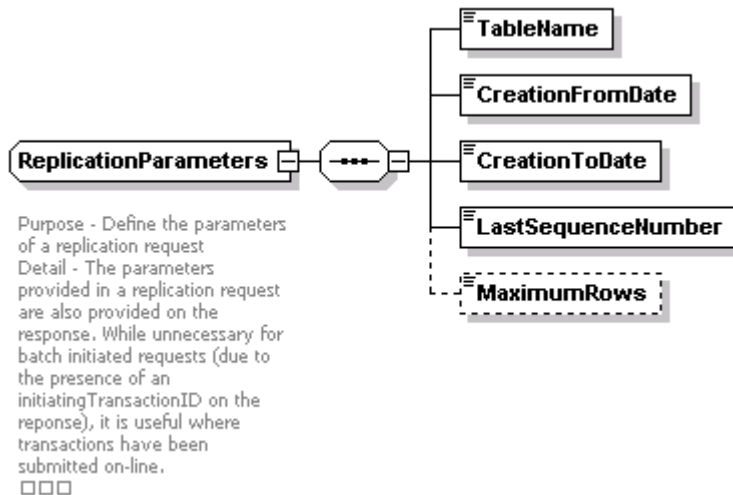

3.24. Transactions

- No change

4. Disclaimer

Independent Confirmation - ASWG strongly advises that all information or material contained in this file should be independently verified before use. The user may need to inform themselves of other relevant information or business processes.

No Warranty – Neither ASWG nor any of ASWG’s advisers, consultants or other contributors to this file (or their respective associated companies, businesses, partners, directors, officers or employees) make any representation or warranty, express or implied, as to the currency, accuracy, reliability or completeness of the information or material contained in, referred to in or accessed from this file.

`xmlns:ase="urn:aseXML:r10"`

`xsi:schemaLocation="urn:aseXML:r10 http://www.nemmco.com.au/aseXML/schemas/r10/aseXML_r10.xsd"`

No Liability - To the maximum extent permitted by law, neither ASWG nor any of its advisers, consultants or other contributors to this file (or their respective associated companies, businesses, partners, directors, officers or employees) shall have any liability (whether arising from negligence or otherwise) in respect of the use of the file or information contained in, referred to in or accessed from this file (including any reliance on the currency, accuracy, reliability or completeness of the information).